

gaviota
Sun Life Specialist

Catálogo 2016

Roller Shutter
and garage doors

Volet Roulant
et porte de garage

Persianas y Puertas enrollables

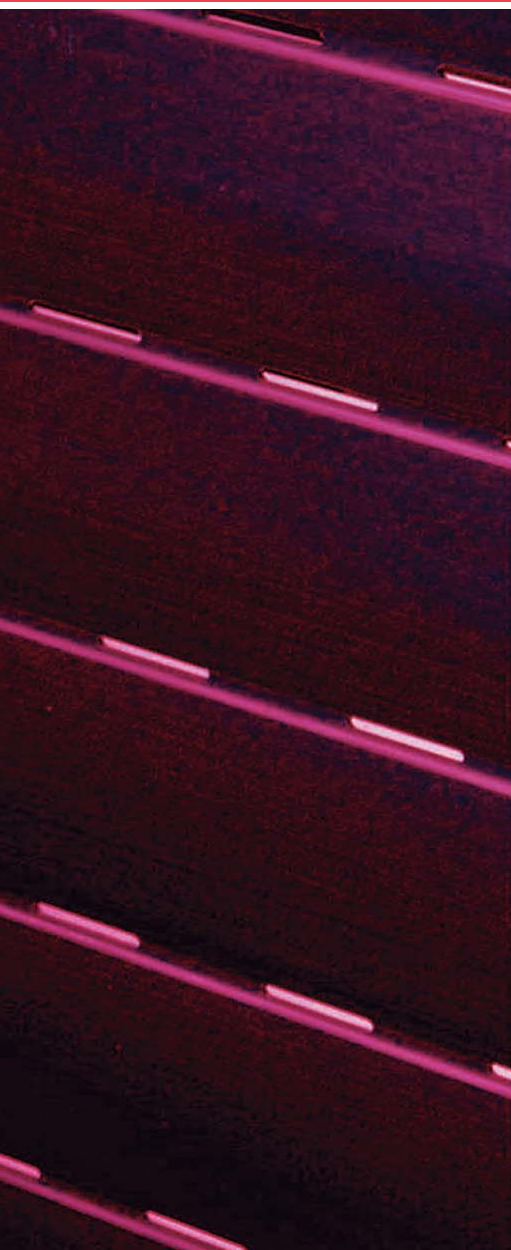



CAJÓN COMPACTO SISTEMAS DE MONTAJE	3
Assembly System / Caisson Monobloc	
SISTEMAS DE ACCIONAMIENTO DE LA PERSIANA	5
Action Systems / Systèmes D ´accionament	
PARTES DE LA PERSIANA	6
Components / Composants	
CAJÓN COMPACTO PVC ESTÁNDAR	7
Square Box / Coffre Carré	
CAJÓN COMPACTO CON TAPAS DE ALUMINIO EXTRUSIÓN	8
Square Box with Aluminium Extruded Covers	
Coffre Carré avec Trappe en Alu Extrudé	
CAJÓN COMPACTO PVC RECUBIERTO CON ALUMINIO	9
Square Box with Aluminium Cover / Coffre Carré avec Trappe en Alu	
CAJÓN PVC DECO	10
Box Deco / Coffre Deco	
CAJÓN PVC DECO RECUBIERTO DE ALUMINIO.....	11
Box Deco/Alu / Coffre Deco/Alu	
PVC TAMAÑOS GRANDES	12
PVC Big Size / PVC Grand Taille	
CAJÓN ALUMINIO	13
Aluminium Box / Coffre Aluminium	
ACCESORIOS	14
Accessories / Accessorie	
MOTORES	15
Motors / Moteurs	
LAMAS DE PVC	16
PVC Slats / Lames de PVC	
LAMAS DE ALUMINIO PERFILADO	21
Profiled Aluminium Slats / Lames Profilées	
LAMA ALUMINIO EXTRUSIÓN	27
Extruded Aluminium / Lames Extrudées	
GÚIAS DE PVC	36
PVC Guides / Coulisses PVC	
GÚIAS DE ALUMINIUM	37
Aluminium Guide / Coulisses en Aluminium	

CÁJON COMPACTO - SISTEMAS DE MONTAJE

MONOBLOCK SYSTEM - ASSEMBLY SYSTEMS / C AISSON MONOBLOCK - SYSTÈMES DE MONTAGE



El sistema de montaje más utilizado actualmente es el Sistema Compacto, aunque tradicionalmente se utilizó el Cajón de registro de obra y posteriormente el Montaje Mini:

Con el SISTEMA COMPACTO, de amplia aceptación e implementación en el mercado, el cajón de persiana se coloca justo encima de la ventana, formando un bloque compacto que simplifica la instalación y ofrece un aspecto elegante. Además, facilita el acceso al mecanismo interior para mantenimiento y reparaciones. Este sistema es compatible con cualquier tipo de carpintería del mercado y evita los capialzados tradicionales de grandes dimensiones. Es el sistema recomendable para obras nuevas o de reposición de ventanas.

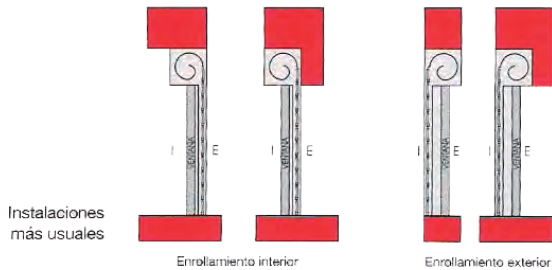

Compacto PVC (con lama de aluminio)
PVC Compact (aluminium slat)/(lames d'aluminium)

Es la solución económica con prestaciones solventes. Se compone del Cajón de PVC enrasado con testeros de aluminio o plástico. En la figura se muestra la lama de persiana termoacústica curva, de aluminio laminado rellena de espuma de poliuretano, con un excelente enrollamiento y diseño estético.



Compacto PVC + EXTRUSIÓN PVC Compact + EXTRUDED/EXTRUDEÉ

Es la solución con ruptura de puente térmico y homogeneidad de color. Se trata de un cajón combinado de PVC y aluminio extrusionado que permite obtener ruptura de puente térmico y altos niveles de aislamiento acústico.

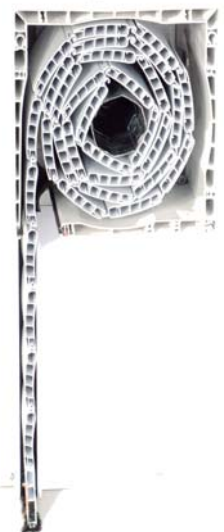

CÁJON COMPACTO - SISTEMAS DE MONTAJE

MONOBLOCK SYSTEM - ASSEMBLY SYSTEMS / C AISSON MONOBLOCK - SYSTÈMES DE MONTAGE



El SISTEMA MINI está pensado para posibilitar la instalación de una persiana cuando tenemos una ventana sin persiana y no queremos hacer obra ni cambiar dicha ventana. El cajón no queda encima de la carpintería como en el caso del Sistema Compacto, sino que se instala por el exterior, delante de la ventana o sobre la fachada, de manera sencilla y sin apenas necesidad de hacer obra. Al quedar el cajón por fuera de la ventana, no hay transferencia térmica posible, economizando además el gasto de energía.

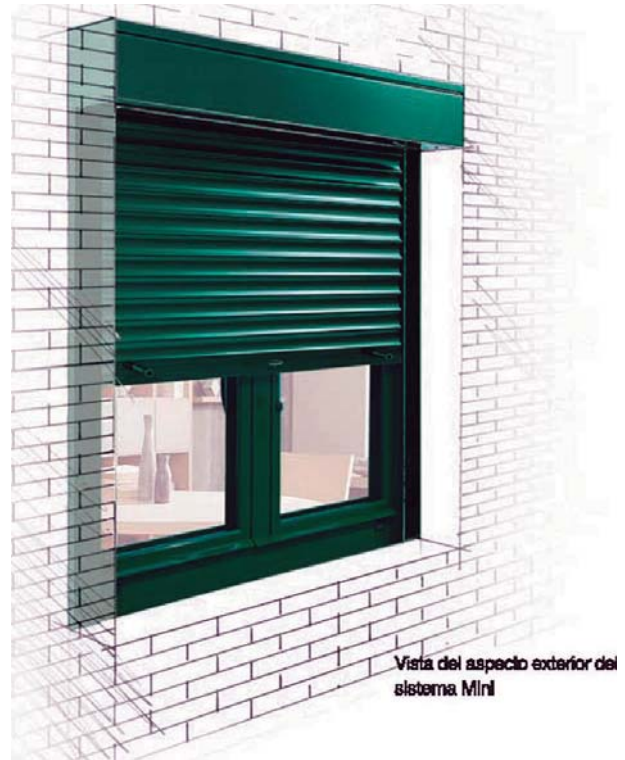

Vista del aspecto exterior del sistema Mini

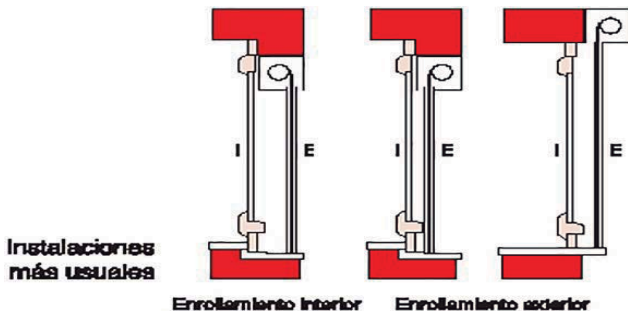

El SISTEMA TRADICIONAL no requiere cajón como tal, pues los componentes y el tejido de la persiana se registran en el muro (cajón de registro de obra). Supone por tanto mayor obra, realizando un hueco en el muro para el registro de la persiana. Además, requiere la colocación de algún tipo de tapa en el interior de la vivienda para acceder al mecanismo para mantenimiento y reparaciones. Permite obtener grandes niveles de aislamiento.

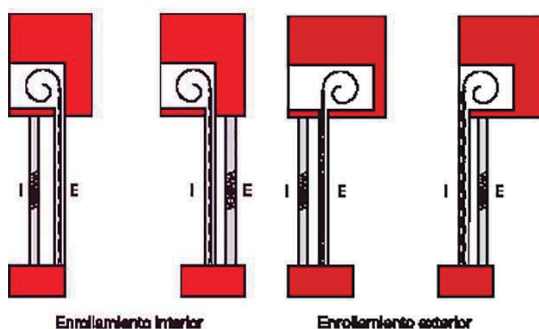

CÁJON COMPACTO - SISTEMAS DE MONTAJE

MONOBLOCK SYSTEM - ASSEMBLY SYSTEMS / C AISSON MONOBLOCK - SYSTÈMES DE MONTAGE



The most widespread assembly system is currently the Compact System, although the traditional built-in box system and the Mini system have also been used in the past.

Bien qu'autrefois le système de montage le plus fréquent était le coffre du treuil puis le montage Mini, le plus utilisé dans l'actualité est le système Compact :

In the COMPACT SYSTEM, which is widely accepted in the market, the shutter box is placed above the window, forming a compact block that simplifies the installation and creates an elegant appearance.

This system also allows easy access to the internal mechanism for maintenance and repairs. This system is compatible with all types of joinery on the market and avoids the traditional brick-box. The compact system is recommended on new constructions or for the replacement of windows

Avec le SYSTÈME COMPACT, qui bénéficie d'une forte acceptation et mise en œuvre sur le marché, le coffre de la persienne est mis en place juste sur la fenêtre tout en formant un bloc compact qui simplifie son installation et offre un aspect élégant. De plus, il rend facile l'accès au mécanisme intérieur pour son entretien et des éventuelles réparations. Ce système est compatible avec tout type de charpenterie du marché et évite les grands coffres traditionnels. Il s'agit d'un système conseillé pour des nouveaux travaux ou des remplacements de fenêtres

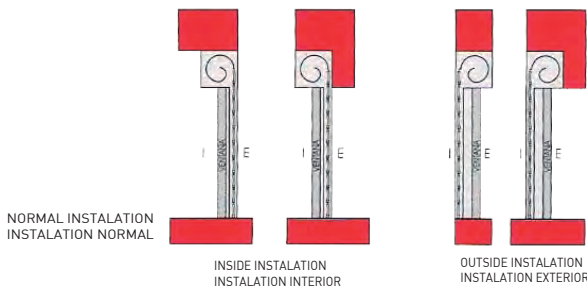

Compacto PVC (con lama de aluminio)
PVC Compact (aluminium slat)/(lames d'aluminium)

Compacto PVC + EXTRUSIÓN PVC
Compact + EXTRUDED/EXTRUDÉ

Matching the appropriate box to the window is essential to guarantee the levels of heat insulation and soundproofing. The compact box supports the combination of different kinds of profiles to adapt the product to the building requirements. By using 1, 2 or 3 aluminium panels depending on the type of installation, the colour can be matched on the box and window, both on the inside and outside of the property.



Le choix du bon coffre selon le type de fenêtre est essentiel pour garantir les niveaux d'isolation thermo-acoustique et d'étanchéité de l'ensemble. Le coffre compact permet de combiner différents types de profilés pour une meilleure adaptation aux besoins des travaux. L'utilisation d'un, de deux ou de trois couvercles en aluminium en fonction du type d'installation permet d'obtenir une couleur et une finition

The most cost-effective solution.

It includes the PVC box with aluminium or plastic caps. The image shows an example of a curved thermal insulation and soundproofing shutter slat, made of laminate aluminium with polyurethane foam, offering excellent rolling qualities and a high-level aesthetic design. This solution provides a thermal barrier and uniform colour. It consists of a combined PVC and extruded aluminium box that creates a thermal barrier and the highest levels of sound insulation

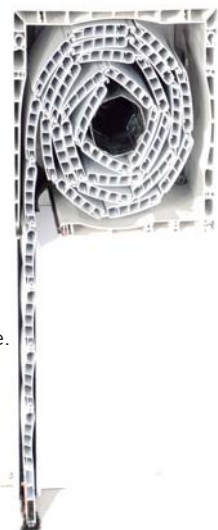

Il s'agit d'une solution économique avec des prestations solvables qui est composée du coffre PVC arasé en aluminium ou en plastique. L'image ci-contre représente la lame de la persienne thermo-acoustique courbée, en aluminium laminé contenant de la mousse de polyuréthane avec un design et enroulement excellents.

Il s'agit d'une solution avec rupture du pont thermique et homogénéité dans les couleurs. Il s'agit d'un coffre combiné de PVC et d'aluminium extrudé qui permet d'obtenir la rupture du pont thermique et de hauts niveaux d'isolation acoustique.

CÁJON COMPACTO - SISTEMAS DE MONTAJE

MONOBLOCK SYSTEM - ASSEMBLY SYSTEMS / C AISSON MONOBLOCK - SYSTÈMES DE MONTAGE



The MINI System is designed to allow the installation of a shutter on a window that does not have a shutter without remodelling the property or changing the window.

Unlike the Compact System, which sits on top of the joinery, the Mini System is installed outside, in front of the window or on the façade. It is a simple operation that barely requires any work. The box is placed outside the window, preventing thermal transference and saving energy.

Le SYSTÈME MINI est conçu pour permettre l'installation d'une persienne dans le cas d'une fenêtre sans persienne et lorsque le client ne souhaite pas faire de travaux ni changer de fenêtre. Le coffre n'est pas par-dessus la charpenterie comme dans le cas du système Compact, mais est installé à l'extérieur, devant la fenêtre ou sur la façade, d'une manière simple et sans besoin de travaux. Comme le coffre reste sur la partie extérieure de la fenêtre, aucun transfert thermique n'est possible, économisant ainsi la dépense énergétique.

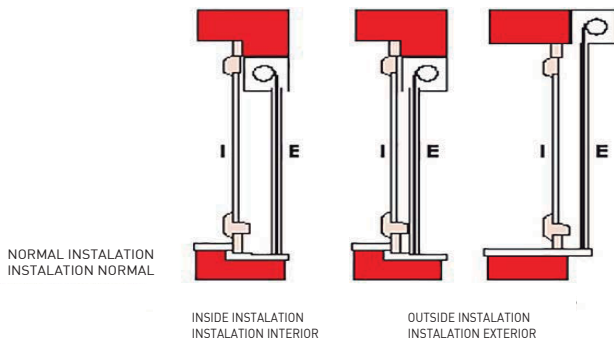

The TRADITIONAL SYSTEM does not need a box, since the components and shutter roll into the wall.

This system requires more work, since a gap has to be made in the wall for the shutter. It also needs the installation of a cover inside the property to access the mechanism for maintenance and repairs. The system ensures high levels of insulation.

Le SYSTÈME TRADITIONNEL ne requiert aucun coffre car les composants et le tissu de la persienne sont à l'intérieur du mur (coffre du treuil). Il demande donc plus de travaux car le charpentier doit faire un trou dans le mur pour le treuil de la persienne. De plus, le système requiert la mise en place d'un type de couvercle à l'intérieur du foyer afin d'accéder au mécanisme pour l'entretien et les réparations et permet d'obtenir de hauts niveaux d'isolation.

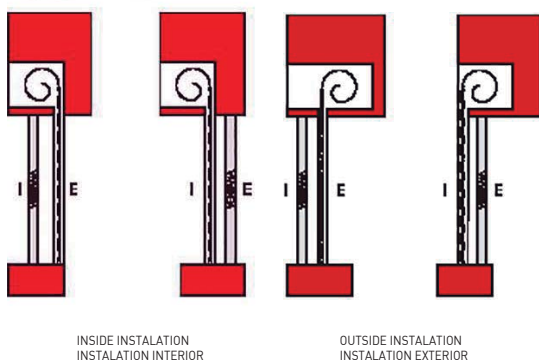

CINTA

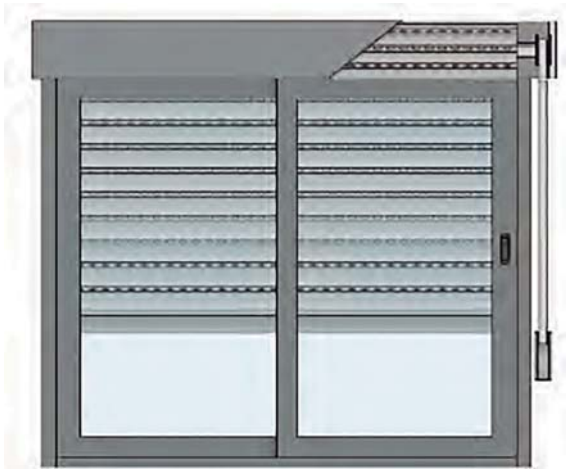

CINTA, Sistema más extendido y económico, por su simplicidad y seguridad. Existe la posibilidad de recogedor empotrado y abatible

TAPE, more economic, and extended system by its simplicity and security. The possibility of flush and folding dustpan.

SANGLE, plus économique et le système plus étendu par sa simplicité et sa sécurité. La possibilité de ramasse-poussière affleurant et pliage

CARDAN

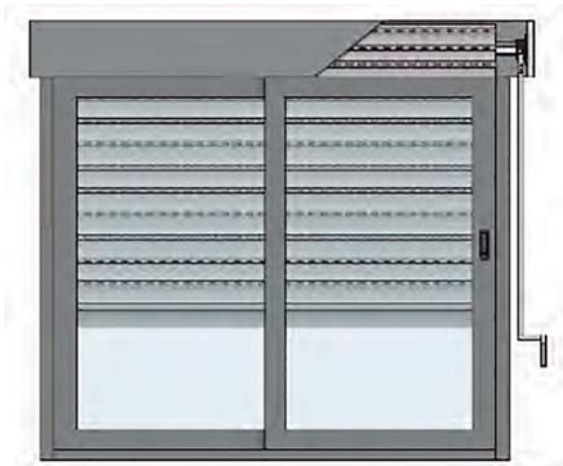

CARDAN, consiste en un sistema multiplicador que mediante engranajes acciona la persiana transmitiendo el movimiento de una manivela exterior. Este sistema es utilizado para persianas de peso superior.

CARDAN, it consists of a multiplier system that blind operated through gears transmitting the movement of an exterior lever. This system is used for blinds.

CARDAN, il se compose d'un système de multiplicateur que les aveugles exploité par des engrenages transmettant le mouvement d'un levier extérieur. Ce système est utilisé pour stores avec un poids plus élevé.

MOTOR

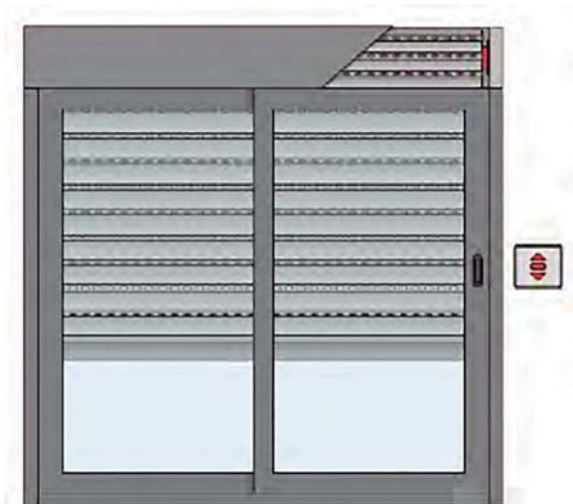

MOTOR, sistema que nos permite el control eficiente de la vivienda. Con un control adecuado, supone un ahorro del 10% en energía, permitiéndonos aprovechar el máximo de luz en invierno y protegiéndonos en verano. La seguridad se incrementa, ya que proporciona mayor resistencia a la elevación (combinado con tirantes de seguridad) Permite simular presencia con la automatización del sistema.

ENGINE, system that allows an efficient control of the house. With adequate control, it saves up to a 10% energy. It allows to take advantage of maximum light, winter and protection in summer. Security is increased because it provides more lift resistance (combined with safety straps) it allows simulate presence with the automation system.

MOTEUR, système qui permet un contrôle plus efficace du logement. Avec un contrôle adéquat, il permet une économie énergétique du 10, ce qui nous permet obtenir le maximum de lumière en hiver et protection en été.

La sécurité est renforcée, car il offre plus résistance de lever (combiné avec sangles de sécurité) Il permet de simuler la présence avec le système d'automatisation.

CÁJON COMPACTO - PARTES DE LA PERSIANA

MONOBLOCK SYSTEM - COMPONENTS/ C AISSON MONOBLOCK - COMPOSANTS

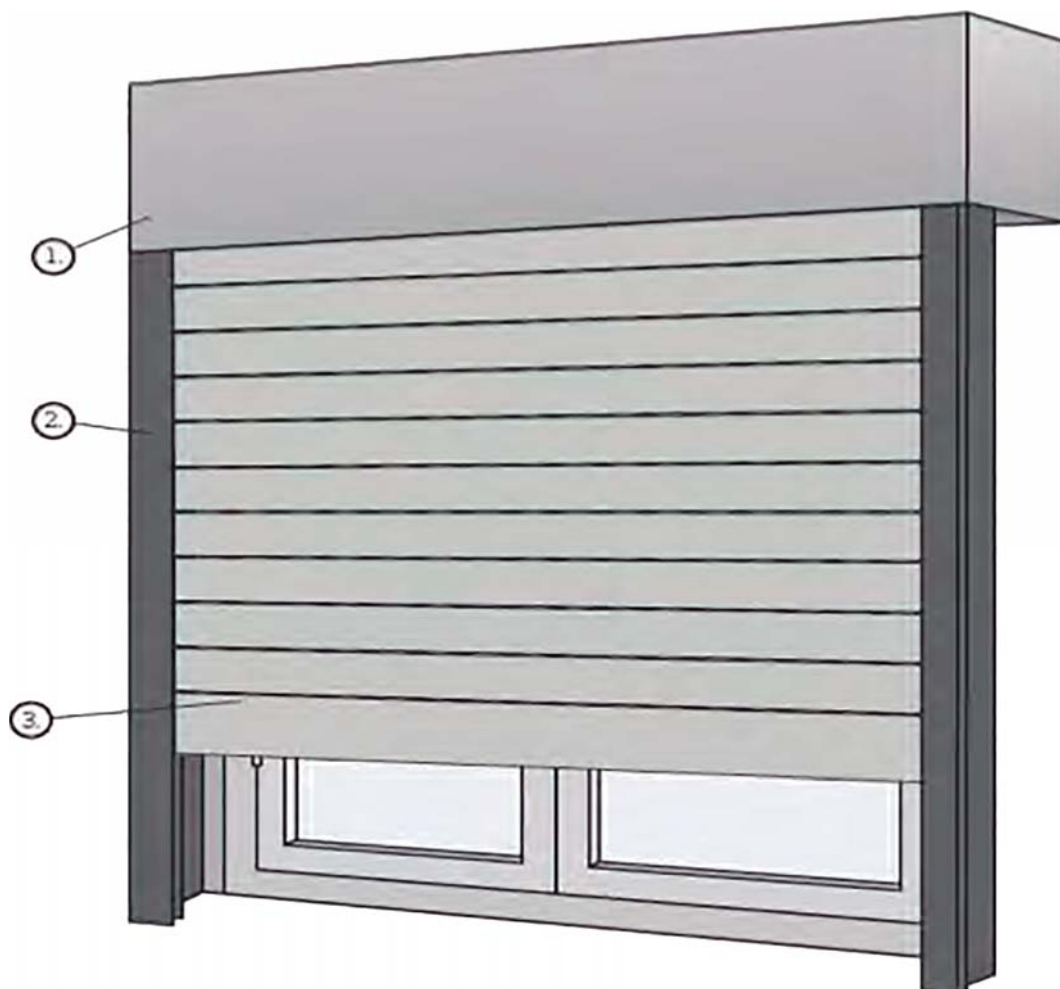

1 CAJÓN BOX/CAISSON

PVC PVC / PVC

Aluminio Perfilado Aluminium / Aluminium Profilé

Aluminio Extrusión Aluminium Extruded / Aluminium Extrudé

2 GUIAS GUIDES/COULISSES

PVC PVC/PVC

Aluminio Extrusión Aluminium Extruded/Aluminium Extrudé

3 Persiana BLIND/VOLET ROULANT

PVC PVC/PVC

Aluminio Perfilado Aluminium/Aluminium Profilé

Aluminio Extrusión Aluminium Extrude/Aluminium Extrudé

CAJONES DE PERSIANA

CAISSON VOLET ROULANT

ROLLER SHUTTER BOX



gaviota

Sun Life Specialist

CÁJON COMPACTO PVC - CUADRADO ESTÁNDAR

MONOBLOCK SYSTEM PVC - SQUARE BOX/ CAISSON MONOBLOCK PVC - COFFRE CARRÉ



155/185/200

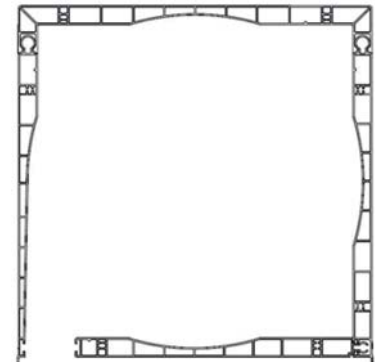

DATOS TÉCNICOS TECHNICAL DATA/DONNÉES TECHNIQUES

	C155	C185	C200
COEFICIENTE DE TRANSMISIÓN TÉRMICA "USB" EN ISO 10077-2:2008	1.8W/m2K	1.9W/m2K	1.5W/m2K
AI SLAMIENTO ACÚSTICO AL RUIDO AÉREO EN ISO 140-3:1995	RW = 27db Rw(C;Ctr)=27(-1;-4)dB	RW = 30 db Rw(C;Ctr)=30(-2;-7)dB	RW = 30db Rw(C;Ctr)=30(-2;-7)dB
PERMEABILIDA AL AIRE EN ISO 1026:2000	CLASE 2	CLASE 2	CLASE 2
ESTANQUIDAD AL AGUA EN ISO 1027:2000	CLASE E750	CLASE 6A	CLASE E900
RESISTENCIA AL VIENTO (SEGURIDAD) EN ISO 12211:2000 - APDO. 7.4	3000 Pa	3000 Pa	2700 Pa

90031155 - CÓDIGO/CODE/CODE - 155 BLANCO/WHITE/ BLANC
90031165 - CÓDIGO/CODE/CODE - 185 BLANCO/WHITE/ BLANC
90031175 - CÓDIGO/CODE/CODE - 200 BLANCO/WHITE/ BLANC

Acabados: color base* , foliados film pvc, foliados aluminio, lacados
finishes: base color , pvc film wrapping, aluminium wrapping, painted
finis: couleurs base , pvc film enrobeuses, aluminium enrobeuses, peinture

* DESCRIPCIÓN COLORES

ENROLLAMIENTO ROLLING DIAMETER/ENROULEMENT CAJÓN INCLUIDO/BOX INCLUDED/ CAISSON INCLUS

Lama	Eje	C155	C185	C200
GV-39	42	1850	2900	3100
	60	1650	2700	2950
GV-45 ECO	42	1650	2600	3300
	60	1500	2400	3100
GV-45	42	1700	3000	3250
	60	1500	2800	3050
GV-39 PVC	42	1650	2700	3250
	60	1500	2500	3050
GV-44 PVC	42	1680	2600	3300
	60	1500	2400	3100
GV-24 MICRO	42			
	60		1185	1800
GV-45 AUTOBL.	42			
	60	1200	2000	2400
ORIENTABLE	42			
	60		1600	2000
GV-40 EXT	42	1350	2050	2600
	60	1150	1900	2400
ECOCLIM	42			
	60		1400	1900

CÁJON COMPACTO PVC - CUADRADO CON TAPAS DE ALUMINIO DE EXTR.

MONOBLOCK SYSTEM - SQUARE BOX WITH ALUMINIUM EXTRUDED COVER/ CAISSON MONOBLOCK - COFFRE CARRÉ AVEC TRAPPE EN ALU EXTRUDÉ

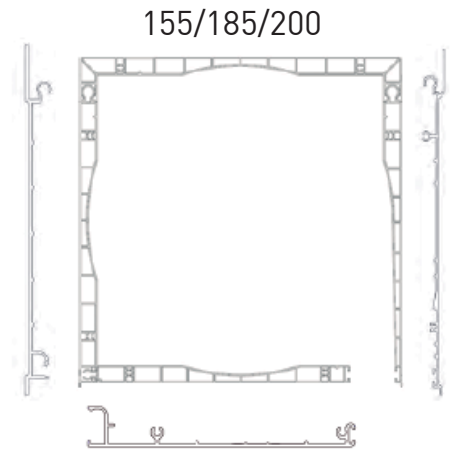

DATOS TÉCNICOS TECHNICAL DATA/DONNÉES TECHNIQUES

	C155	C185	C200
COEFICIENTE DE TRANSMISIÓN TÉRMICA "USB" EN ISO 10077-2:2008	1.8W/m2K	1.9W/m2K	1.5W/m2K
AISLAMIENTO ACÚSTICO AL RUIDO AÉREO EN ISO 140-3:1995	RW = 27db Rw(C;Ctr)=27(-1;-4)dB	RW = 30 db Rw(C;Ctr)=30(-2;-7)dB	RW = 30db Rw(C;Ctr)=30(-2;-7)dB
PERMEABILIDAD AL AIRE EN ISO 1026:2000	CLASE 2	CLASE 2	CLASE 2
ESTANQUIDAD AL AGUA EN ISO 1027:2000	CLASE E750	CLASE 6A	CLASE E900
RESISTENCIA AL VIENTO (SEGURIDAD) EN ISO 12211:2000 - APDO. 7.4	3000 Pa	3000 Pa	2700 Pa

90031155 - CÓDIGO/CODE/CODE - 155 BLANCO/WHITE/ BLANC
90031165 - CÓDIGO/CODE/CODE - 185 BLANCO/WHITE/ BLANC
90031175 - CÓDIGO/CODE/CODE - 200 BLANCO/WHITE/ BLANC

Acabados: color base* , foliados film pvc, foliados aluminio, lacados
finishes: base color , pvc film wrapping, aluminium wrapping, painted
finis: couleurs base , pvc film enrobeuses, aluminium enrobeuses, peinture

* DESCRIPCIÓN COLORES

ENROLLAMIENTO ROLLING DIAMETER/ENROULEMENT CAJÓN INCLUIDO/BOX INCLUDED/ CAISSON INCLUS

Lama	Eje	C155	C185	C200
GV-39	42	1850	2900	3100
	60	1650	2700	2950
GV-45 ECO	42	1650	2600	3300
	60	1500	2400	3100
GV-45	42	1700	3000	3250
	60	1500	2800	3050
GV-39 PVC	42	1650	2700	3250
	60	1500	2500	3050
GV-44 PVC	42	1680	2600	3300
	60	1500	2400	3100
GV-24 MICRO	42			
	60		1185	1800
GV-45 AUTOBL.	42			
	60	1200	2000	2400
ORIENTABLE	42			
	60		1600	2000
GV-40 EXT	42	1350	2050	2600
	60	1150	1900	2400
ECOCLIM	42			
	60		1400	1900

CÁJON COMPACTO PVC -CUADRADO CON TAPAS DE AL. PERFILADO

MONOBLOCK SYSTEM - SQUARE BOX WITH ALUMINIUM COVER / C AISSON MONOBLOCK - COFFRE CARRÉ AVEC TRAPPE EN ALU



155/185

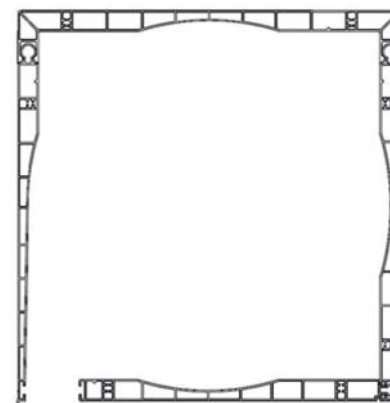

DATOS TÉCNICOS TECHNICAL DATA/DONNÉES TECHNIQUES

	C155	C185
COEFICIENTE DE TRANSMISIÓN TÉRMICA "USB" EN ISO 10077-2:2008	1.8 W/m2K	1.9 W/m2K
AISLAMIENTO ACÚSTICO AL RUIDO AÉREO EN ISO 140-3:1995	RW = 27db Rw(C;Ctr)=27(-1;-4)dB	RW = 30db Rw(C;Ctr)=30(-2;-7)dB
PERMEABILIDA AL AIRE EN ISO 1026:2000	CLASE 2	CLASE 2
ESTANQUIDAD AL AGUA EN ISO 1027:2000	CLASE E750	CLASE 6A
RESISTENCIA AL VIENTO (SEGURIDAD) EN ISO 12211:2000 - APDO. 7.4	3000 Pa	3000 Pa

90031155?? - CÓDIGO/CODE/CODE - 155 BLANCO/WHITE/ BLANC

90031165?? - CÓDIGO/CODE/CODE - 185 BLANCO/WHITE/ BLANC

Acabados: color base* , foliados film pvc, foliados aluminio, lacados
finishes: base color , pvc film wrapping, aluminium wrapping, painted
finis: couleurs base , pvc film enrobeuses, aluminium enrobeuses, peinture

* DESCRIPCIÓN COLORES

ENROLLAMIENTO ROLLING DIAMETER/ENROULEMENT CAJÓN INCLUIDO/BOX INCLUDED/ CAISSON INCLUS

Lama	Eje	C155	C185
GV-39	42	1850	2900
	60	1650	2700
GV-45 ECO	42	1650	2600
	60	1500	2400
GV-45	42	1700	3000
	60	1500	2800
GV-39 PVC	42	1650	2700
	60	1500	2500
GV-44 PVC	42	1680	2600
	60	1500	2400
GV-24 MICRO	42		
	60		1185
GV-45 AUTOBL.	42		
	60	1200	2000
ORIENTABLE	42		
	60		1600
GV-40 EXT	42	1350	2050
	60	1150	1900
ECOCLIM	42		
	60		1400

CÁJON COMPACTO PVC- DECO

MONOBLOCK SYSTEM - BOX DECO/ CAISSON MONOBLOCK - COFFRE DECO



155/185/200

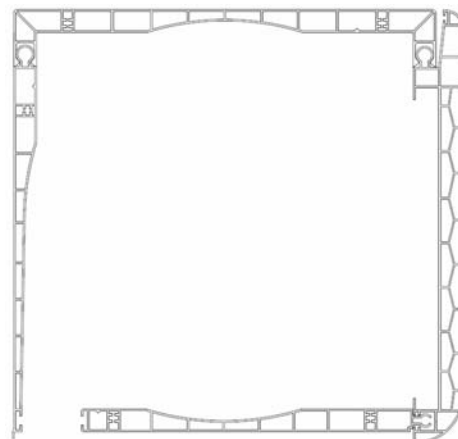

DATOS TÉCNICOS TECHNICAL DATA/DONNÉES TECHNIQUES

	A155	A185	A200
COEFICIENTE DE TRANSMISIÓN TÉRMICA "USB" EN ISO 10077-2:2008	2 W/m2K	1.0 W/m2K	1.0 W/m2K
AI SLAMI ENTO ACÚSTICO AL RUIDO AÉREO EN ISO 140-3:1995	Rw = 29db Rw(C;Ctr)=27(-1;-4)dB	Rw = 40db Rw(C;Ctr)=30(-2;-7)dB	Rw = 51db Rw(C;Ctr)=30(-2;-7)dB
PERMEABILIDA AL AIRE EN ISO 1026:2000	CLASE 4	CLASE 3	CLASE 3
ESTANQUIDAD AL AGUA EN ISO 1027:2000	CLASE E3000	CLASE E3000	CLASE E3000
RESISTENCIA AL VIENTO (SEGURIDAD) EN ISO 12211:2000 - APDO. 7.4	3000 Pa	3000 Pa	3000 Pa

990031125 - CÓDIGO/CODE/CODE - 155 BLANCO/WHITE/ BLANC
90031130 - CÓDIGO/CODE/CODE - 185 BLANCO/WHITE/ BLANC
90031135 - CÓDIGO/CODE/CODE - 200 BLANCO/WHITE/ BLANC

Acabados: color base* , foliados film pvc, foliados aluminio, lacados
finishes: base color , pvc film wrapping, aluminium wrapping, painted
finis: couleurs base , pvc film enrobeuses, aluminium enrobeuses, peinture

* DESCRIPCIÓN COLORES

ENROLLAMIENTO ROLLING DIAMETER/ENROULEMENT CAJÓN INCLUIDO/BOX INCLUDED/ CAISSON INCLUS

Lama	Eje	C155	C185	C200
GV-39	42	1850	2900	3100
	60	1650	2700	2950
GV-45 ECO	42	1650	2600	3300
	60	1500	2400	3100
GV-45	42	1700	3000	3250
	60	1500	2800	3050
GV-39 PVC	42	1650	2700	3250
	60	1500	2500	3050
GV-44 PVC	42	1680	2600	3300
	60	1500	2400	3100
GV-24 MICRO	42			
	60		1185	1800
GV-45 AUTOBL.	42			
	60	1200	2000	2400
ORIENTABLE	42			
	60		1600	2000
GV-40 EXT	42	1350	2050	2600
	60	1150	1900	2400
ECOCLIM	42			
	60		1400	1900

CÁJON COMPACTO PVC- DECO PVC + ALU.

MONOBLOCK SYSTEM - BOX DECO PVC + ALU/ CAISSON MONOBLOCK - COFFRE DECO PVC + ALU



PVC + ALU

155/185/200

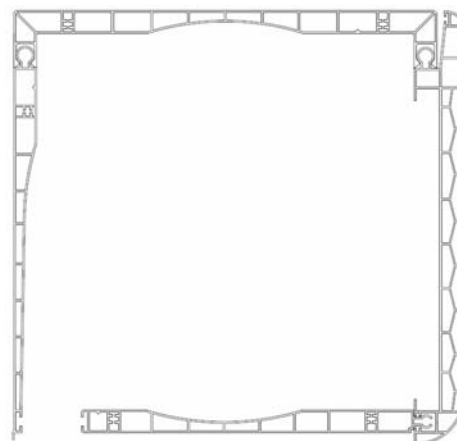

DATOS TÉCNICOS TECHNICAL DATA/DONNÉES TECHNIQUES

	A155	A185	A200
COEFICIENTE DE TRANSMISIÓN TÉRMICA "USB" EN ISO 10077-2:2008	2 W/m ² K	1.0 W/m ² K	1.0 W/m ² K
AISLAMIENTO ACÚSTICO AL RUIDO AÉREO EN ISO 140-3:1995	RW = 29db Rw(C;Ctr)=27(-1;-4)dB	RW = 40db Rw(C;Ctr)=30(-2;-7)dB	RW = 51db Rw(C;Ctr)=30(-2;-7)dB
PERMEABILIDA AL AIRE EN ISO 1026:2000	CLASE 4	CLASE 3	CLASE 3
ESTANQUIDAD AL AGUA EN ISO 1027:2000	CLASE E3000	CLASE E3000	CLASE E3000
RESISTENCIA AL VIENTO (SEGURIDAD) EN ISO 12211:2000 - APDO. 7.4	3000 Pa	3000 Pa	3000 Pa

990031125 - CÓDIGO/CODE/CODE - 155 BLANCO/WHITE/ BLANC

90031130 - CÓDIGO/CODE/CODE - 185 BLANCO/WHITE/ BLANC

90031135 - CÓDIGO/CODE/CODE - 200 BLANCO/WHITE/ BLANC

Acabados: color base* , foliados film pvc, foliados aluminio, lacados
finishes: base color , pvc film wrapping, aluminium wrapping, painted
finis: couleurs base , pvc film enrobeuses, aluminium enrobeuses, peinture

* DESCRIPCIÓN COLORES

ENROLLAMIENTO ROLLING DIAMETER/ENROULEMENT CAJÓN INCLUIDO/BOX INCLUDED/ CAISSON INCLUS

Lama	Eje	C155	C185	C200
GV-39	42	1850	2900	3100
	60	1650	2700	2950
GV-45 ECO	42	1650	2600	3300
	60	1500	2400	3100
GV-45	42	1700	3000	3250
	60	1500	2800	3050
GV-39 PVC	42	1650	2700	3250
	60	1500	2500	3050
GV-44 PVC	42	1680	2600	3300
	60	1500	2400	3100
GV-24 MICRO	42			
	60		1185	1800
GV-45 AUTOBL.	42			
	60	1200	2000	2400
ORIENTABLE	42			
	60		1600	2000
GV-40 EXT	42	1350	2050	2600
	60	1150	1900	2400
ECOCLIM	42			
	60		1400	1900

CÁJON COMPACTO PVC- TAMAÑOS GRANDES

MONOBLOCK SYSTEM - PVC BIG SIZE / CAISSON MONOBLOCK - PVC GRAND TAILLE



225

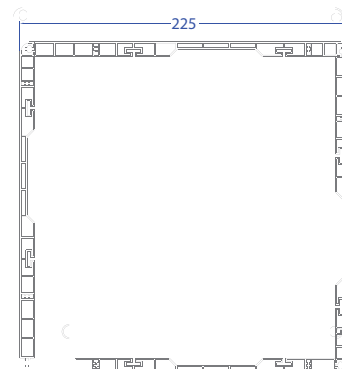

990031125 - CÓDIGO/CODE/CODE - 155 BLANCO/WHITE/ BLANC

275

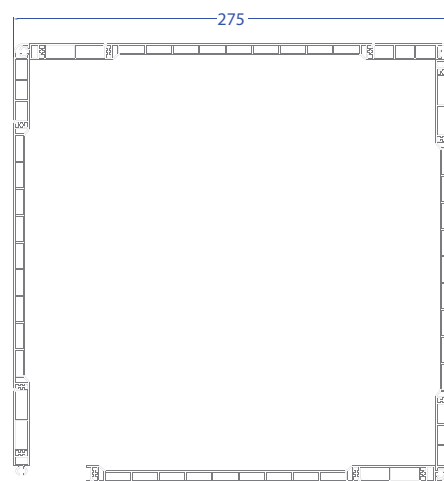

990031125 - CÓDIGO/CODE/CODE - 155 BLANCO/WHITE/ BLANC

310

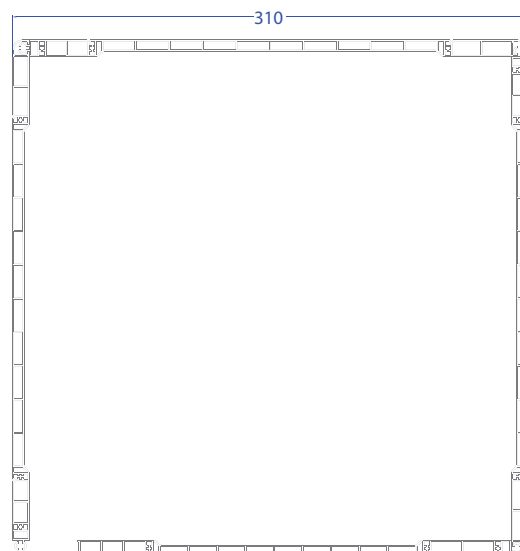

990031125 - CÓDIGO/CODE/CODE - 155 BLANCO/WHITE/ BLANC

Acabados: color base , foliados film pvc, foliados aluminio, lacados
finishes: base color , pvc film wrapping, aluminium wrapping, painted
finis: couleurs base , pvc film enrobeuses, aluminium enrobeuses, peinture

* DESCRIPCIÓN COLORES

CÁJON COMPACTO Y MINI - ALUMINIO PERFILADO

MONOBLOCK SYSTEM - ALUMINIUM PROFILED BOXES / CAISSON MONOBLOCK - COFFRES ALUMINIUM PROFILÉ



4 PART
137-150-165-180-205-25

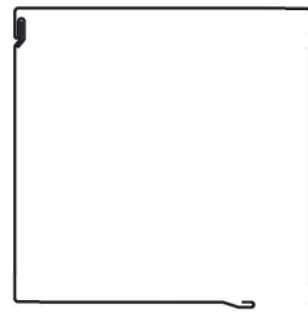

990031125 - CÓDIGO/CODE/COE - 155 BLANCO/WHITE/ BLANC



45° 2 PART
137-150-165-180-205-250-300-350-400

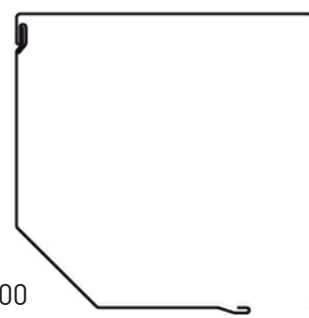

990031125 - CÓDIGO/CODE/COE - 155 BLANCO/WHITE/ BLANC



2 PART CUR.
137-150-165-180-205-250

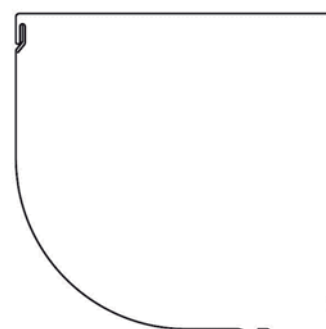

990031125 - CÓDIGO/CODE/COE - 155 BLANCO/WHITE/ BLANC

Acabados: Consultar.
finishes: Consult.
finis: Consulter.

LAMAS DE PERSIANA

LAME VOLET ROULANT
ROLLER SHUTTER SLATS



gaviota

Sun Life Specialist



GV-39 PVC

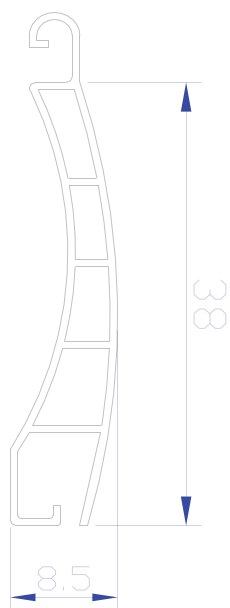

DATOS TÉCNICOS TECHNICAL DATA / CARACTERISTIQUES TECHNIQUES	
Superficie de cobertura Coverage/Couverture	39 mm
Espesor nominal Thickness/Épaisseur	8 mm
Peso aproximado por m ² Theoric Weight M ² /Poids théorique M ²	3,10 kg
Nº de lamas/m. de altura. Slats by meter height/Lames par metre de hauteur	25,6
Ancho máximo recomendado Max recommande witch/Largeur max. recomen- dable	1,40 m
Alto máximo recomendado Max. height/Max hauteur	3 m
Peso por metro lineal de lama Weight m.l./Poids m.l.	0,130 gr/ml
Embalaje Packaging/Emballage	50 lamas/ paq.

CERTIFICACIONES MERCADO CE/CE MARK CERTIFICATIONS/CERTIFICATION MARCAGE CE			
ENSAYO	RESULTADO	DIMENSIONES (mm)*	
RESISTENCIA AL VIENTO Resistance to wind Resistance au vent	V*2:100 Pa=46 km/h	1350 x 1685	
		ancho width	x alto x height largueur x hauteur
DIÁMETRO DE ENROLLAMIENTO	137	165	180
ALTURA DE PERSIANA	170	250	300

UNE EN 1932. Clasificación según la tabla 5 (apdo. 4.4) de la Norma UNE EN 13659:2004. Classification upon table 5 (section 4.4) of the UNE EN 13659:2004 regulation. Classification selon tableau 5 (p. 4.4) de la Norme UNE EN 13659:2004.

90031155?? - CÓDIGO/CODE/CODE - 155 BLANCO/WHITE/ BLANC

Alturas totales en mm. Total heights in mm. Hauters total en mm.

Las alturas indicadas incluyen el cajón y el remate, es decir, se refieren al hueco para el compacto.

The indicated heights include the box and the end slat, that is, they are referred to the hollow for the shutter.

Les hauteurs indiquées incluent le coffre et la lame finale, c'est à dire, concernent l' espace occupé par le volet roulant complet

* DESCRIPCIÓN COLORES



GV-44 PVC

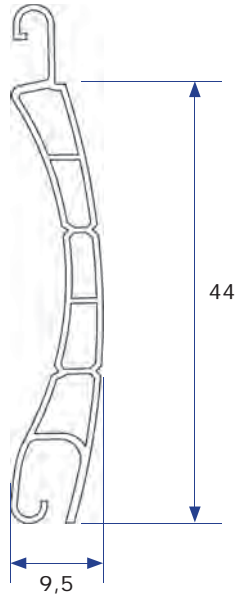

DATOS TÉCNICOS TECHNICAL DATA / CARACTERISTIQUES TECHNIQUES	
Superficie de cobertura Coverage/Couverture	44 mm
Espesor nominal Thickness/Épaisseur	9,5 mm
Peso aproximado por m ² Theoric Weight M ² /Poids théorique M ²	3,30 kg
Nº de lamas/m. de altura. Slats by meter height/Lames par metre de hauteur	22,7
Ancho máximo recomendado Max recommande witch/Largeur max. recomen- dable	1,50 m
Alto máximo recomendado Max. height/Max hauteur	3 m
Peso por metro lineal de lama Weight m.l./Poids m.l.	0,145 gr/ml
Embalaje Packaging/Emballage	40 lamas/ paq.

CERTIFICACIONES MERCADO CE/CE MARK CERTIFICATIONS/CERTIFICATION MARCAGE CE		
ENSAYO	RESULTADO	DIMENSIONES (mm)*

RESISTENCIA
AL VIENTO
Resistance to wind
Resistance au vent

V*3:150 Pa= 56 km/h 1350 x 1685

ancho x alto
width x height
largeur x hauteur

DIÁMETRO DE ENROLLAMIENTO	137	165	180
ALTURA DE PERSIANA	170	250	300

UNE EN 1932. Clasificación según la tabla 5 (apdo. 4.4) de la Norma UNE EN 13659:2004. Classification upon table 5 (section 4.4) of the UNE EN 13659:2004 regulation. Classification selon tableau 5 (p. 4.4) de la Norme UNE EN 13659:2004.

90031155?? - CÓDIGO/CODE/CODE - 155 BLANCO/WHITE/ BLANC

Alturas totales en mm. Total heights in mm. Hauters total en mm.

Las alturas indicadas incluyen el cajón y el remate, es decir, se refieren al hueco para el compacto.

The indicated heights include the box and the end slat, that is, they are referred to the hollow for the shutter.

Les hauteurs indiquées incluent le coffre et la lame finale, c'est à dire, concernant l' espace occupé par le volet roulant complet

* DESCRIPCIÓN COLORES



GV-45 PVC RECTA

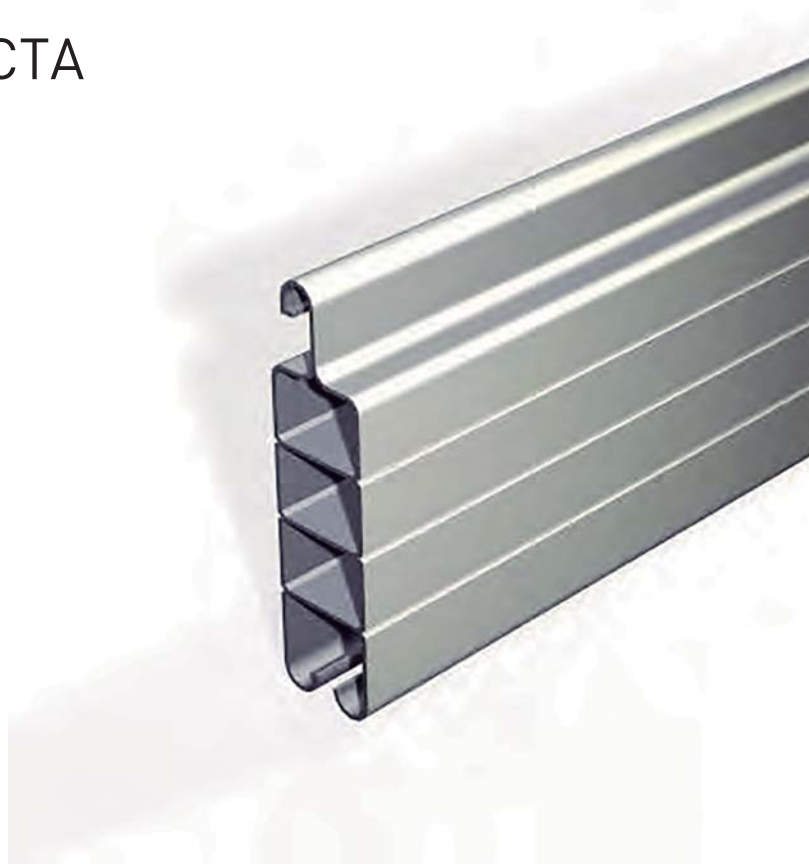
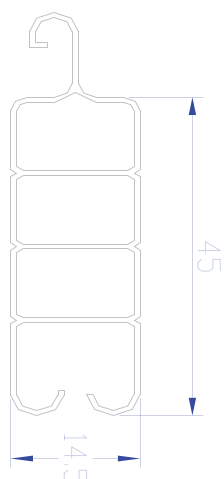

DATOS TÉCNICOS TECHNICAL DATA / CARACTERISTIQUES TECHNIQUES	
Superficie de cobertura Coverage/Couverture	45 mm
Espesor nominal Thickness/Épaisseur	14,5 mm
Peso aproximado por m ² Theoric Weight M ² /Poids théorique M ²	4,45 kg
Nº de lamas/m. de altura. Slats by meter height/Lames par metre de hauteur	22,2
Ancho máximo recomendado Max recommande witch/Largeur max. recommandable	2,20 m
Alto máximo recomendado Max. height/Max hauteur	3,00 m
Peso por metro lineal de lama Weight m.l./Poids m.l.	0,200 gr/ml
Embalaje Packaging/Emballage	20 Lamas/ paq.

CERTIFICACIONES MERCADO CE/CE MARK CERTIFICATIONS/CERTIFICATION MARCAGE CE		
ENSAYO	RESULTADO	DIMENSIONES (mm) *

RESISTENCIA
AL VIENTO
Resistance to wind
Resistance au vent

V*5:400 Pa = 92 km/h 1350 x 1685

ancho x alto
width x height
largeur x hauteur

DIÁMETRO DE ENROLLAMIENTO	190	220	260
ALTURA DE PERSIANA	1250	2000	2500

UNE EN 1932. Clasificación según la tabla 5 (apdo. 4.4) de la Norma UNE EN 13659:2004. Classification upon table 5 (section 4.4) of the UNE EN 13659:2004 regulation. Classification selon tableau 5 (p. 4.4) de la Norme UNE EN 13659:2004.

90031155?? - CÓDIGO/CODE/CODE - 155 BLANCO/WHITE/ BLANC

Alturas totales en mm. Total heights in mm. Hauters total en mm.

* DESCRIPCIÓN COLORES

PERSIANAS - LAMA PVC

ROLLER SHUTTER - PVC SLAT/VOLET ROULANT - LAME PVC



GV-50 PVC

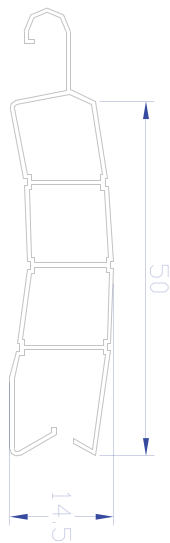

DATOS TÉCNICOS TECHNICAL DATA / CARACTERISTIQUES TECHNIQUES	
Superficie de cobertura Coverage/Couverture	50 mm
Espesor nominal Thickness/Épaisseur	14,5 mm
Peso aproximado por m ² Theoric Weight M ² /Poids théorique M ²	4,2 kg
Nº de lamas/m. de altura. Slats by meter height/Lames par metre de hauteur	20
Ancho máximo recomendado Max recommande witch/Largeur max. recomen- dable	2,30 m
Alto máximo recomendado Max. height/Max hauteur	3 m
Peso por metro lineal de lama Weight m.l./Poids m.l.	0,210 gr/ml
Embalaje Packaging/Emballage	20 lamas/ paq.

CERTIFICACIONES MARCADO CE/CE MARK CERTIFICATIONS/CERTIFICATION MARGAGE CE		
ENSAYO	RESULTADO	DIMENSIONES (mm)*

RESISTENCIA
AL VIENTO
Resistance to wind
Resistance au vent

V*5:400 Pa=92 km/h 1350 x 1685

ancho x alto
widht x height
largeur x hauteur

DIÁMETRO DE ENROLLAMIENTO	170	210	230
------------------------------	-----	-----	-----

ALTURA DE
PERSIANA

1250

2000

2500

UNE EN 1932. Clasificación según la tabla 5 (apdo. 4.4) de la Norma UNE EN 13659:2004. Classification upon table 5 (section 4.4) of the UNE EN 13659:2004 regulation. Classification selon tableau 5 (p. 4.4) de la Norme UNE EN 13659:2004.

90031155?? - CÓDIGO/CODE/CODE - 155 BLANCO/WHITE/ BLANC

Alturas totales en mm. Total heights in mm. Hauters total en mm.

* DESCRIPCIÓN COLORES



GV-56 PVC

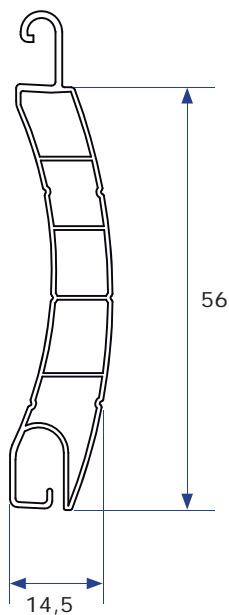

DATOS TÉCNICOS TECHNICAL DATA / CARACTERISTIQUES TECHNIQUES

Superficie de cobertura Coverage/Couverture	56 mm
Espesor nominal Thickness/Épaisseur	14,5 mm
Peso aproximado por m ² Theoric Weight M ² /Poids théorique M ²	3,8 kg
Nº de lamas/m. de altura. Slats by meter height/Lames par metre de hauteur	17,8
Ancho máximo recomendado Max recommande witch/Largeur max. recomen- dable	2,30 m
Alto máximo recomendado Max. height/Max hauteur	3 m
Peso por metro lineal de lama Weight m.l./Poids m.l.	0,210 gr/ml
Embalaje Packaging/Emballage	20 lamas/ paq.

CERTIFICACIONES MERCADO CE/CE MARK CERTIFICATIONS/CERTIFICATION MARGAGE CE

ENSAYO	RESULTADO	DIMENSIONES (mm) *
--------	-----------	--------------------

RESISTENCIA
AL VIENTO
Resistance to wind
Resistance au vent

V*5:400 Pa=92 km/h 1350 x 1685

ancho x alto
width x height
largeur x hauteur

DIÁMETRO DE ENROLLAMIENTO	170	210	220
------------------------------	-----	-----	-----

ALTURA DE
PERSIANA

1250 2000 2500

UNE EN 1932. Clasificación según la tabla 5 (apdo. 4.4) de la Norma UNE EN 13659:2004. Classification upon table 5 (section 4.4) of the UNE EN 13659:2004 regulation. Classification selon tableau 5 (p. 4.4) de la Norme UNE EN 13659:2004.

90031155?? - CÓDIGO/CODE/CODE - 155 BLANCO/WHITE/ BLANC

* DESCRIPCIÓN COLORES

PERSIANAS - LAMA AL PERFILADA

ROLLER SHUTTER - AL PROFILED SLAT/VOLET ROULANT - LAME ALU PROFILÉ



GV-39 AL PF

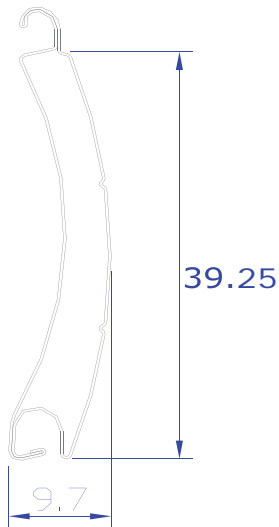

DATOS TÉCNICOS

TECHNICAL DATA / CARACTERISTIQUES TECHNIQUES

Superficie de cobertura Coverage/Couverture	39,25 mm
Espesor nominal Thickness/épaisseur	8,38 mm
Peso aproximado por m ² Theoric weight M ² /Poids théorique M ²	2,8 kg
Nº de lamas/m. de altura. Slats by meter height/Lames par metre de hauteur	25,47
Ancho máximo recomendado Max recommande witch/Largeur max. recommandable	2,60 m
Alto máximo recomendado Max. height/Max hauteur	3 m
Peso por metro lineal de lama weight m.l./Poids m.l.	0,114 gr/ml
Embalaje Packaging/Emballage	65 lamas/ paq.

CERTIFICACIONES MARCADO CE/CE

MARK CERTIFICATIONS/CERTIFICATION MARCAGE CE

ENSAYO	RESULTADO	DIMENSIONES (mm) *
--------	-----------	--------------------

RESISTENCIA
AL VIENTO
Resistance to wind
Resistance au vent

V*5:400 Pa=92km/h 1740 x 2200

ancho x alto
width x height
largeur x hauteur

	137	165	180	205
ALTURA DE PERSIANA	1650	2800	2900	3800

UNE EN 1932. Clasificación según la tabla 5 (apdo. 4.4) de la Norma UNE EN 13659:2004. Classification upon table 5 (section 4.4) of the UNE EN 13659:2004 regulation. Classification selon tableau 5 (p. 4.4) de la Norme UNE EN 13659:2004.

90031155?? - CÓDIGO/CODE/CODE - 155 BLANCO/WHITE/ BLANC

Alturas totales en mm. Total heights in mm. Hauters total en mm.

Las alturas indicadas incluyen el cajón y el remate, es decir, se refieren al hueco para el compacto.

The indicated heights include the box and the end slat, that is, they are referred to the hollow for the shutter.

Les hauteurs indiquées incluent le coffre et la lame finale, c'est à dire, concernant l' espace occupé par le volet roulant complet

* DESCRIPCIÓN COLORES

PERSIANAS - LAMA AL PERFILADA

ROLLER SHUTTER - AL PROFILED SLAT/VOLET ROULANT - LAME ALU PROFILÉ



GV-45 AL PF

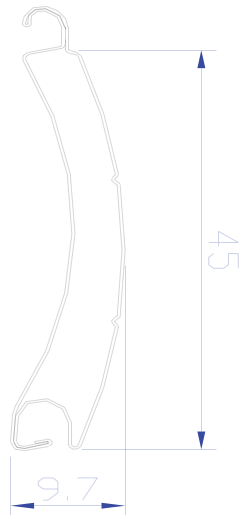

DATOS TÉCNICOS TECHNICAL DATA / CARACTERISTIQUES TECHNIQUES	
Superficie de cobertura Coverage/Couverture	45 mm
Espesor nominal Thickness/Épaisseur	9,7 mm
Peso aproximado por m ² Theoric Weight M ² /Poids théorique M ²	2,8 kg
Nº de lamas/m. de altura. Slats by meter height/Lames par metre de hauteur	22,2
Ancho máximo recomendado Max recommande witch/Largeur max. recomendable	2,60 m
Alto máximo recomendado Max. height/Max hauteur	3 m
Peso por metro lineal de lama Weight m.l./Poids m.l.	0,114 gr/ml
Embalaje Packaging/Emballage	50 lamas/ paq.

CERTIFICACIONES MARCADO CE/CE MARK CERTIFICATIONS/CERTIFICATION MARCAGE CE		
ENSAYO	RESULTADO	DIMENSIONES (mm)*

RESISTENCIA
AL VIENTO
Resistance to wind
Resistance au vent

V*5:400 Pa=92km/h 1740 x 2200

ancho x alto
width x height
largeur x hauteur

DIÁMETRO DE ENROLLAMIENTO	137	165	180	205
ALTURA DE PERSIANA	1650	2800	2900	3800

UNE EN 1932. Clasificación según la tabla 5 (apdo. 4.4) de la Norma UNE EN 13659:2004. Classification upon table 5 (section 4.4) of the UNE EN 13659:2004 regulation. Classification selon tableau 5 (p. 4.4) de la Norme UNE EN 13659:2004.

90031155?? - CÓDIGO/CODE/CODE - 155 BLANCO/WHITE/BLANC

Alturas totales en mm. Total heights in mm. Hauters total en mm.

Las alturas indicadas incluyen el cajón y el remate, es decir, se refieren al hueco para el compacto.

The indicated heights include the box and the end slat, that is, they are referred to the hollow for the shutter.

Les hauteurs indiquées incluent le coffre et la lame finale, c'est à dire, concernant l'espace occupé par le volet roulant complet

* DESCRIPCIÓN COLORES

PERSIANAS - LAMA AL PERFILADA

ROLLER SHUTTER - AL PROFILED SLAT/VOLET ROULANT - LAME ALU PROFILÉ



GV-45 ECO AL PF

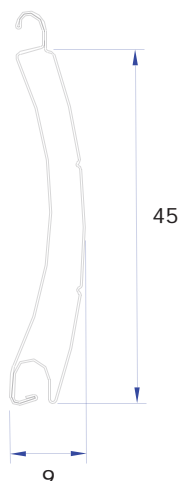

DATOS TÉCNICOS TECHNICAL DATA / CARACTERISTIQUES TECHNIQUES

Superficie de cobertura Coverage/Couverture	45 mm
Espesor nominal Thickness/Épaisseur	9 mm
Peso aproximado por m ² Theoric Weight M ² /Poids théorique M ²	2,35 kg
Nº de lamas/m. de altura. Slats by meter height/Lames par metre de hauteur	22,2
Ancho máximo recomendado Max recommande witch/Largeur max. recommandable	2,50 m
Alto máximo recomendado Max. height/Max hauteur	3 m
Peso por metro lineal de lama Weight m.l./Poids m.l.	0,110 gr/ml
Embalaje Packaging/Emballage	60 lamas/ paq.

CERTIFICACIONES MARCADO CE/CE MARK CERTIFICATIONS/CERTIFICATION MARCAGE CE

ENSAYO	RESULTADO	DIMENSIONES (mm)*
--------	-----------	-------------------

RESISTENCIA
AL VIENTO
Resistance to wind
Resistance au vent

V*4:250 Pa =78 km/h 1740 x 2200

ancho x alto
width x height
largeur x hauteur

DIÁMETRO DE ENROLLAMIENTO	137	165	180	205
---------------------------	-----	-----	-----	-----

ALTURA DE
PERSIANA

1700 2850 3150 3900

UNE EN 1932. Clasificación según la tabla 5 (apdo. 4.4) de la Norma UNE EN 13659:2004. Classification upon table 5 (section 4.4) of the UNE EN 13659:2004 regulation. Classification selon tableau 5 (p. 4.4) de la Norme UNE EN 13659:2004.

90031155?? - CÓDIGO/CODE/CODE - 155 BLANCO/WHITE/ BLANC

Las alturas indicadas incluyen el cajón y el remate, es decir, se refieren al hueco para el compacto.

The indicated heights include the box and the end slat, that is, they are referred to the hollow for the shutter.

Les hauteurs indiquées incluent le coffre et la lame finale, c'est à dire, concernant l' espace occupé par le volet roulant complet

* DESCRIPCIÓN COLORES

PERSIANAS - LAMA AL PERFILADA

ROLLER SHUTTER - AL PROFILED SLAT/VOLET ROULANT - LAME ALU PROFILÉ



GV-45 RECTA AL PF

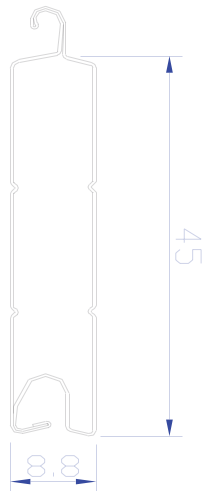

DATOS TÉCNICOS TECHNICAL DATA / CARACTERISTIQUES TECHNIQUES	
Superficie de cobertura Coverage/Couverture	45 mm
Espesor nominal Thickness/Épaisseur	8,8 mm
Peso aproximado por m ² Theoric Weight M ² /Poids théorique M ²	2,90 kg
Nº de lamas/m. de altura. Slats by meter height/Lames par metre de hauteur	22,2
Ancho máximo recomendado Max recommande witch/Largeur max. recommandable	2,90 m
Alto máximo recomendado Max. height/Max hauteur	3 m
Peso por metro lineal de lama Weight m.l./Poids m.l.	0,130 gr/ml
Embalaje Packaging/Emballage	55 lamas/ paq.

CERTIFICACIONES MARCADO CE/CE MARK CERTIFICATIONS/CERTIFICATION MARCAGE CE

ENSAYO	RESULTADO	DIMENSIONES (mm)*
--------	-----------	-------------------

RESISTENCIA
AL VIENTO
Resistance to wind
Resistance au vent

V*6: 600 Pa=112 km/h 1740 x 2200

ancho x alto
width x height
largeur x hauteur

DIÁMETRO DE ENROLLAMIENTO	137	165	180	205
ALTURA DE PERSIANA	1050	1450	1850	1950

UNE EN 1932. Clasificación según la tabla 5 (apdo. 4.4) de la Norma UNE EN 13659:2004. Classification upon table 5 (section 4.4) of the UNE EN 13659:2004 egula - tion. Classification selon tableau 5 (p. 4.4) de la Norme UNE EN 13659:2004.

90031155?? - CÓDIGO/CODE/CODE - 155 BLANCO/WHITE/ BLANC

Alturas totales en mm. Total heights in mm. Hauters total en mm.

Las alturas indicadas incluyen el cajón y el remate, es decir, se refieren al hueco para el compacto.

The indicated heights include the box and the end slat, that is, they are refered to the hollow for the shutter.

Les hauteurs indiquées incluent le coffre et la lame finale, c'est à dire, concernent l' espace occupé par le volet roulant complet

* DESCRIPCIÓN COLORES

PERSIANAS - LAMA AL PERFILADA

ROLLER SHUTTER - AL PROFILED SLAT/VOLET ROULANT - LAME ALU PROFILÉ



GV-55 AL PF

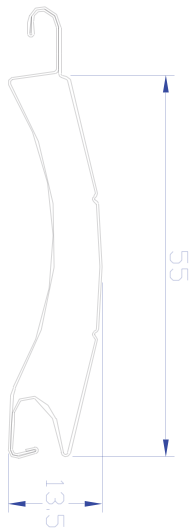

DATOS TÉCNICOS TECHNICAL DATA / CARACTERISTIQUES TECHNIQUES	
Superficie de cobertura Coverage/Couverture	55 mm
Espesor nominal Thickness/Épaisseur	13,5 mm
Peso aproximado por m ² Theoric Weight M ² /Poids théorique M ²	3,00 kg
Nº de lamas/m. de altura. Slats by meter height/Lames par metre de hauteur	18,1
Ancho máximo recomendado Max recommande witch/Largeur max. recomen- dable	4,00m
Alto máximo recomendado Max. height/Max hauteur	3 m
Peso por metro lineal de lama Weight m.l./Poids m.l.	0,165 gr/ml
Embalaje Packaging/Emballage	36 lamas/ paq.

CERTIFICACIONES MARCADO CE/CE MARK CERTIFICATIONS/CERTIFICATION MARCAGE CE		
ENSAYO	RESULTADO	DIMENSIONES (mm)*

RESISTENCIA
AL VIENTO
Resistance to wind
Resistance au vent

V*6: 600 Pa=112 km/h

1740 x 2200

ancho x alto
width x height
largeur x hauteur

DIÁMETRO DE ENROLLAMIENTO	165	180	205	240
ALTURA DE PERSIANA	1200	1400	1950	2250

UNE EN 1932. Clasificación según la tabla 5 (apdo. 4.4) de la Norma UNE EN 13659:2004. Classification upon table 5 (section 4.4) of the UNE EN13659:2004 regulation. Classification selon tableau 5 (p. 4.4) de la Norme UNE EN 13659:2004.

90031155?? - CÓDIGO/CODE/CODE - 155 BLANCO/WHITE/ BLANC

Alturas totales en mm. Total heights in mm. Hauters total en mm.

* DESCRIPCIÓN COLORES

PERSIANAS - LAMA AL PERFILADA

ROLLER SHUTTER - AL PROFILED SLAT/VOLET ROULANT - LAME ALU PROFILÉ



GV-77 AL P



DATOS TÉCNICOS TECHNICAL DATA / CARACTERISTIQUES TECHNIQUES

Superficie de cobertura Coverage/Couverture	77 mm
Espesor nominal Thickness/Épaisseur	20 mm
Peso aproximado por m ² Theoric Weight M ² /Poids théorique M ²	5,08
Nº de lamas/m. de altura. Slats by meter height/Lames par metre de hauteur	12,9
Ancho máximo recomendado Max recommande witch/Largeur max. recomen- dable	4,50 m
Alto máximo recomendado Max. height/Max hauteur	3 m
Peso por metro lineal de lama Weight m.l./Poids m.l.	0,410 gr/ml
Embalaje Packaging/Emballage	15lamas/ paq.

CERTIFICACIONES MARCADO CE/CE MARK CERTIFICATIONS/CERTIFICATION MARCAGE CE

ENSAYO	RESULTADO	DIMENSIONES (mm)*
--------	-----------	-------------------

RESISTENCIA
AL VIENTO
Resistance to wind
Resistance au vent

P*2: 620 Pa=114,5 km/h 3000x 3500

ancho x alto
width x height
largeur x hauteur

DIÁMETRO DE ENROLLAMIENTO	250	300	350	400
------------------------------	-----	-----	-----	-----

ALTURA DE
PERSIANA

1800 2650 4310 6200

UNE EN 1932. Clasificación según la tabla 5 (apdo. 4.4) de la Norma UNE EN 13659:2004. Classification upon table 5 (section 4.4) of the UNE EN 13659:2004 regulation. Classification selon tableau 5 (p. 4.4) de la Norme UNE EN 13659:2004.

90031155?? - CÓDIGO/CODE/CODE - 155 BLANCO/WHITE/ BLANC

Alturas totales en mm. Total heights in mm. Hauters total en mm.

Las alturas indicadas incluyen el cajón y el remate, es decir, se refieren al hueco para el compacto.

The indicated heights include the box and the end slat, that is, they are referred to the hollow for the shutter.

Les hauteurs indiquées incluent le coffre et la lame finale, c'est à dire, concernant l' espace occupé par le volet roulant complet

* DESCRIPCIÓN COLORES

PERSIANAS - LAMA AL EXTRUSIÓN

ROLLER SHUTTER - EXTRUDED AL SLAT/VOLET ROULANT - LAME ALU EXTRUDÉ



GV-40 EXTR.



DATOS TÉCNICOS TECHNICAL DATA / CARACTERISTIQUES TECHNIQUES	
Superficie de cobertura Coverage/Couverture	40 mm
Espesor nominal Thickness/Épaisseur	8,7 mm
Peso aproximado por m ² Theoric Weight M ² /Poids théorique M ²	9,00 kg
Nº de lamas/m. de altura. Slats by meter height/Lames par metre de hauteur	25
Ancho máximo recomendado Max recommande witch/Largeur max. recommandable	3,00m
Alto máximo recomendado Max. height/Max hauteur	3,00 m
Peso por metro lineal de lama Weight m.l./Poids m.l.	0,360 gr/ml
Embalaje Packaging/Emballage	10 Lama paq.

CERTIFICACIONES MARCADO CE/CE MARK CERTIFICATIONS/CERTIFICATION MARCAGE CE		
ENSAYO	RESULTADO	DIMENSIONES (mm) *

RESISTENCIA
AL VIENTO
Resistance to wind
Resistance au vent

v*6:600 Pa= 112 km/h

3000 x 2500

ancho x alto
width x height
largeur x hauteur

DIÁMETRO DE ENROLLAMIENTO	137	165	180	205
ALTURA DE PERSIANA	950	1750	1850	2750

UNE EN 1932. Clasificación según la tabla 5 (apdo. 4.4) de la Norma UNE EN 13659:2004. Classification upon table 5 (section 4.4) of the UNE EN 13659:2004 regulation. Classification selon tableau 5 (p. 4.4) de la Norme UNE EN 13659:2004.

90031155?? - CÓDIGO/CODE/CODE - 155 BLANCO/WHITE/ BLANC

Alturas totales en mm. Total heights in mm. Hauters total en mm.

Las alturas indicadas incluyen el cajón y el remate, es decir, se refieren al hueco para el compacto.

The indicated heights include the box and the end slat, that is, they are referred to the hollow for the shutter.

Les hauteurs indiquées incluent le coffre et la lame finale, c'est à dire, concernant l' espace occupé par le volet roulant complet

* DESCRIPCIÓN COLORES

GV-24 MICROPERFORADA EXTR.

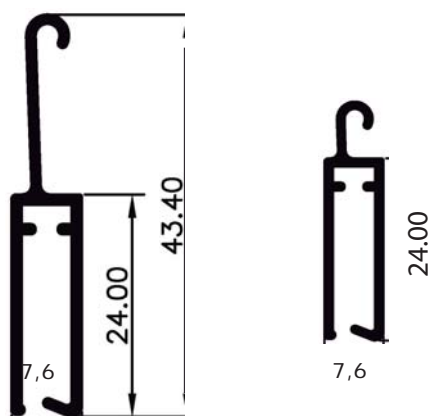

DATOS TÉCNICOS TECHNICAL DATA / CARACTERISTIQUES TECHNIQUES

Superficie de cobertura Coverage/Couverture	24 mm
Espesor nominal Thickness/Épaisseur	7,6 mm
Peso aproximado por m ² Theoric Weight M ² /Poids théorique M ²	6,30
Nº de lamas/m. de altura. Slats by meter height/Lames par metre de hauteur	41,67
Ancho máximo recomendado Max recommande witch/Largeur max. recommandable	2,57 m
Alto máximo recomendado Max. height/Max hauteur	3,00 m
Peso por metro lineal de lama Weight m.l./Poids m.l.	0,241 gr/ml
Embalaje Packaging/Emballage	10 lamas/ paq.

CERTIFICACIONES MERCADO CE/CE MARK CERTIFICATIONS/CERTIFICATION MARCAGE CE

ENSAYO	RESULTADO	DIMENSIONES (mm)*
--------	-----------	-------------------

RESISTENCIA
AL VIENTO
Resistance to wind
Resistance au vent

V*6: 600 Pa= 112 km/h

2000 x 2500

ancho x alto
width x height
largeur x hauteur

DIÁMETRO DE ENROLLAMIENTO	165	180	205
---------------------------	-----	-----	-----

ALTURA DE
PERSIANA

1165

1580

2200

UNE EN 1932. Clasificación según la tabla 5 (apdo. 4.4) de la Norma UNE EN 13659:2004. Classification upon table 5 (section 4.4) of the UNE EN 13659:2004 regulation. Classification selon tableau 5 (p. 4.4) de la Norme UNE EN 13659:2004.

90031155?? - CÓDIGO/CODE/CODE - 155 BLANCO/WHITE/BLANC

Alturas totales en mm. Total heights in mm. Hauters total en mm.

Las alturas indicadas incluyen el cajón y el remate, es decir, se refieren al hueco para el compacto.

The indicated heights include the box and the end slat, that is, they are referred to the hollow for the shutter.

Les hauteurs indiquées incluent le coffre et la lame finale, c'est à dire, concernant l' espace occupé par le volet roulant complet

* DESCRIPCIÓN COLORES

PERSIANAS - LAMA AL EXTRUSIÓN

ROLLER SHUTTER - EXTRUDED AL SLAT/VOLET ROULANT - LAME ALU EXTRUDÉ



GV-60 EXTR./ DYNAMIC- SECUR*

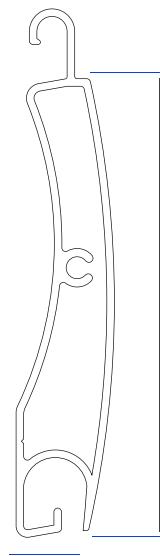

60



* SISTEMA TAPÓN DYNAMIC-SECUR

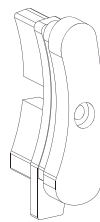

13

DATOS TÉCNICOS TECHNICAL DATA / CARACTERISTIQUES TECHNIQUES

Superficie de cobertura Coverage/Couverture	60 mm
Espesor nominal Thickness/Épaisseur	13 mm
Peso aproximado por m ² Theoric Weight M ² /Poids théorique M ²	7,90 kg
Nº de lamas/m. de altura. Slats by meter height/Lames par metre de hauteur	16,6
Ancho máximo recomendado Max recommande witch/Largeur max. recommandable	4 m
Alto máximo recomendado Max. height/Max hauteur	3,5 m
Peso por metro lineal de lama Weight m.l./Poids m.l.	0,390 gr/ml
Embalaje Packaging/Emballage	10 lamas/ paq.

CERTIFICACIONES MERCADO CE/CE MARK CERTIFICATIONS/CERTIFICATION MARGAGE CE

ENSAYO	RESULTADO	DIMENSIONES (mm)*
--------	-----------	-------------------

RESISTENCIA AL VIENTO Resistance to wind Resistance au vent	V*6: 600 Pa=112 km/h	4000 x 3500
	P*2: ≥620 Pa= 112 km/h	4000 x 3500

ancho x alto
width x height
largeur x hauteur

DIÁMETRO DE ENROLLAMIENTO	205	250	300
---------------------------	-----	-----	-----

ALTURA DE PERSIANA	1650/1765	2230/2350	4260/4500
--------------------	-----------	-----------	-----------

Eje 60/70 60/70 tube

UNE EN 1932. Clasificación según la tabla 5 (apdo. 4.4) de la Norma UNE EN 13659:2004. Classification upon table 5 (section 4.4) of the UNE EN 13659:2004 regulation. Classification selon tableau 5 (p. 4.4) de la Norme UNE EN 13659:2004.

90031155?? - CÓDIGO/CODE/CODE - 155 BLANCO/WHITE/ BLANC

Alturas totales en mm. Total heights in mm. Hauters total en mm.

Las alturas indicadas incluyen el cajón y el remate, es decir, se refieren al hueco para el compacto.

The indicated heights include the box and the end slat, that is, they are referred to the hollow for the shutter.

Les hauteurs indiquées incluent le coffre et la lame finale, c'est à dire, concernant l' espace occupé par le volet roulant complet

* DESCRIPCIÓN COLORES

PERSIANAS - LAMA AL EXTRUSIÓN

ROLLER SHUTTER - EXTRUDED AL SLAT/VOLET ROULANT - LAME ALU EXTRUDÉ



GV-45 AUTOBLOCK EXTR.

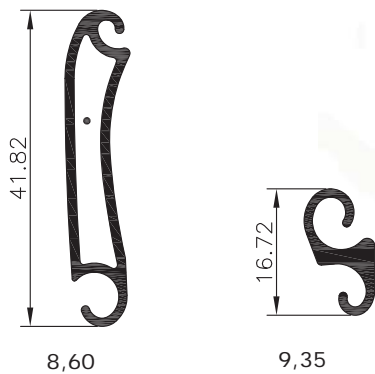

DATOS TÉCNICOS TECHNICAL DATA / CARACTERISTIQUES TECHNIQUES

Superficie de cobertura Coverage/Couverture	60 mm
Espesor nominal Thickness/Épaisseur	13 mm
Peso aproximado por m ² Theoric Weight M ² /Poids théorique M ²	7,90 kg
Nº de lamas/m. de altura. Slats by meter height/Lames par metre de hauteur	16,6
Ancho máximo recomendado Max recommande witch/Largeur max. recomendable	4 m
Alto máximo recomendado Max. height/Max hauteur	3,5 m
Peso por metro lineal de lama Weight m.l./Poids m.l.	0,390 gr/ml
Embalaje Packaging/Emballage	10 lamas/ paq.

CERTIFICACIONES MARCADO CE/CE MARK CERTIFICATIONS/CERTIFICATION MARCAGE CE

ENSAYO	RESULTADO	DIMENSIONES (mm)*
RESISTENCIA AL VIENTO Resistance to wind Resistance au vent	V*6: 600 Pa=112 km/h P*2: ≥620 Pa= 112 km/h	4000 x 3500 4000 x 3500

ancho x alto
width x height
largeur x hauteur

DIÁMETRO DE ENROLLAMIENTO	205	250	300
ALTURA DE PERSIANA	1650/1765	2230/2350	4260/4500
	Eje 60/70 60/70 tube		

UNE EN 1932. Clasificación según la tabla 5 (apdo. 4.4) de la Norma UNE EN 13659:2004. Classification upon table 5 (section 4.4) of the UNE EN 13659:2004 regulation. Classification selon tableau 5 (p. 4.4) de la Norme UNE EN 13659:2004.

90031155?? - CÓDIGO/CODE/CODE - 155 BLANCO/WHITE/ BLANC

Alturas totales en mm. Total heights in mm. Hauters total en mm.

Las alturas indicadas incluyen el cajón y el remate, es decir, se refieren al hueco para el compacto.

The indicated heights include the box and the end slat, that is, they are referred to the hollow for the shutter.

Les hauteurs indiquées incluent le coffre et la lame finale, c'est à dire, concernant l' espace occupé par le volet roulant complet

* DESCRIPCIÓN COLORES

PERSIANAS - LAMA AL EXTRUSIÓN

ROLLER SHUTTER - EXTRUDED AL SLAT/VOLET ROULANT - LAME ALU EXTRUDÉ



GV-45 ECOCLIM AUTOBLOCK EXTR.

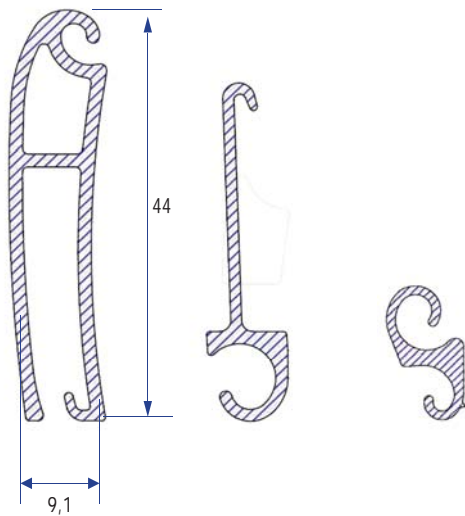

DATOS TÉCNICOS TECHNICAL DATA / CARACTERISTIQUES TECHNIQUES	
Superficie de cobertura Coverage/Couverture	45 mm
Espesor nominal Thickness/Épaisseur	9,1 mm
Peso aproximado por m ² Theoric Weight M ² /Poids théorique M ²	12,54 kg
Nº de lamas/m. de altura. Slats by meter height/Lames par metre de hauteur	21
Ancho máximo recomendado Max recommande witch/Largeur max. recomen- dable	2,75 m
Alto máximo recomendado Max. height/Max hauteur	3 m
Peso por metro lineal de lama Weight m.l./Poids m.l.	
Embalaje Packaging/Emballage	10 lamas/ paq.

CERTIFICACIONES MARCADO CE/CE MARK CERTIFICATIONS/CERTIFICATION MARCAGE CE			
ENSAYO	RESULTADO	DIMENSIONES (mm)*	
RESISTENCIA AL VIENTO Resistance to wind Resistance au vent	V*6: 600 Pa=112 km/h	2750 x 2500 <small>ancho x alto width x height largeur x hauteur</small>	
DIÁMETRO DE ENROLLAMIENTO	165	180	205
ALTURA DE PERSIANA	1250	1750	2500

UNE EN 1932. Clasificación según la tabla 5 (apdo. 4.4) de la Norma UNE EN 13659:2004. Classification upon table 5 (section 4.4) of the UNE EN 13659:2004 Regulation. Classification selon tableau 5 (p. 4.4) de la Norme UNE EN 13659:2004.

90031155?? - CÓDIGO/CODE/CODE - 155 BLANCO/WHITE/ BLANC

Alturas totales en mm. Total heights in mm. Hauters total en mm.

Las alturas indicadas incluyen el cajón y el remate, es decir, se refieren al hueco para el compacto.

The indicated heights include the box and the end slat, that is, they are referred to the hollow for the shutter.

Les hauteurs indiquées incluent le coffre et la lame finale, c'est à dire, concernant l' espace occupé par le volet roulant complet

* DESCRIPCIÓN COLORES

PERSIANAS - LAMA AL EXTRUSIÓN

ROLLER SHUTTER - EXTRUDED AL SLAT/VOLET ROULANT - LAME ALU EXTRUDÉ



GV-60 AUTOBLOCK EXTR./ DYNAMIC- SECUR*



DATOS TÉCNICOS TECHNICAL DATA / CARACTERISTIQUES TECHNIQUES

Superficie de cobertura Coverage/Couverture	65 mm
Espesor nominal Thickness/Épaisseur	15 mm
Peso aproximado por m ² Theoric Weight M ² /Poids théorique M ²	11,50 kg
Nº de lamas/m. de altura. Slats by meter height/Lames par metre de hauteur	16
Ancho máximo recomendado Max recommande witch/Largeur max. recomen- dable	4,5 m
Alto máximo recomendado Max. height/Max hauteur	5 m
Peso por metro lineal de lama Weight m.l./Poids m.l.	0,720 gr/ml
Embalaje Packaging/Emballage	10 lamas/ paq.

CERTIFICACIONES MARCADO CE/CE MARK CERTIFICATIONS/CERTIFICATION MARCAGE CE

ENSAYO	RESULTADO	DIMENSIONES (mm)*
RESISTENCIA AL VIENTO Resistance to wind Resistance au vent	V*6:600 Pa=112 km/h	1850 x 2200
	P*3:≥965 Pa= 142,9 km/h	3000 x 3500

* ancho x alto
width x height
largeur x hauteur

DIÁMETRO DE ENROLLAMIENTO	260	270	2800	300
ALTURA DE PERSIANA	2600	3400	3800	4200

UNE EN 1932. Clasificación según la tabla 5 (apdo. 4.4) de la Norma UNE EN 13659:2004. Classification upon table 5 (section 4.4) of the UNE EN 13659:2004 regulation. Classification selon tableau 5 (p. 4.4) de la Norme UNE EN 13659:2004.

90031155?? - CÓDIGO/CODE/CODE - 155 BLANCO/WHITE/ BLANC

Alturas totales en mm. Total heights in mm. Hauters total en mm.

* DESCRIPCIÓN COLORES

PERSIANAS - LAMA AL EXTRUSIÓN

ROLLER SHUTTER - EXTRUDED AL SLAT/VOLET ROULANT - LAME ALU EXTRUDÉ



GV-90 AUTOBLOCK EXTR.

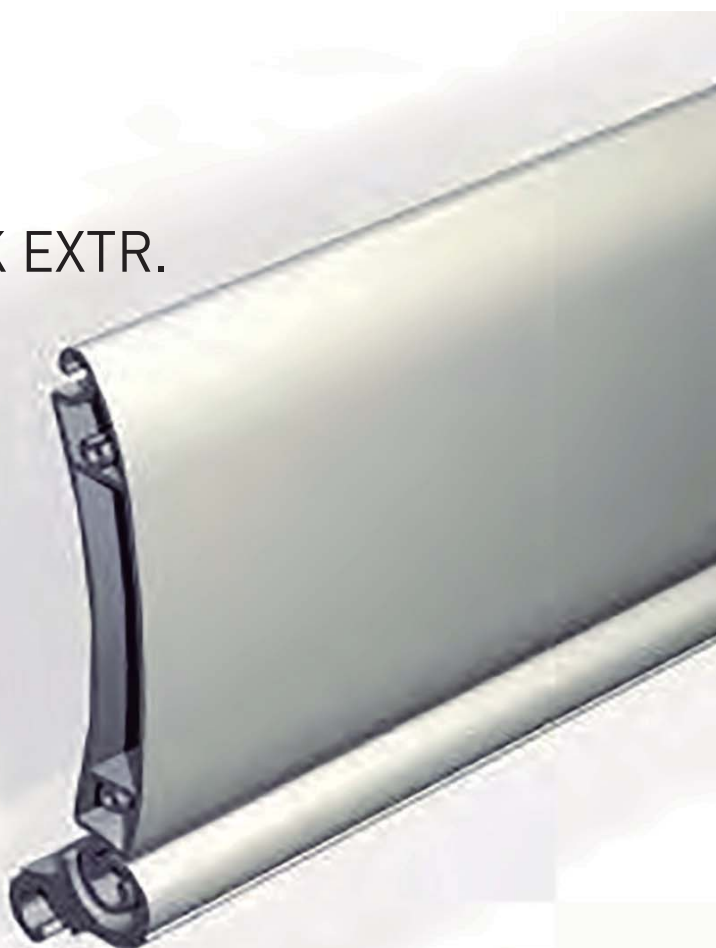
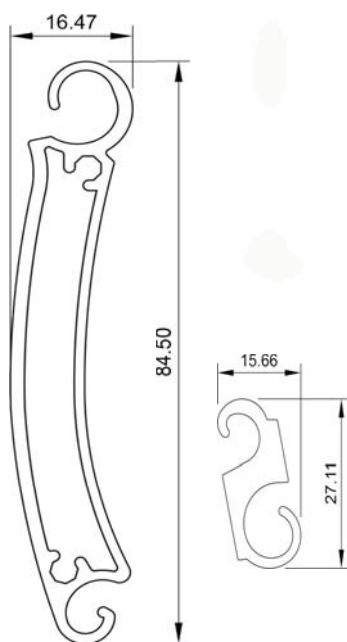

DATOS TÉCNICOS TECHNICAL DATA / CARACTERISTIQUES TECHNIQUES	
Superficie de cobertura Coverage/Couverture	100 mm
Espesor nominal Thickness/Épaisseur	17,3 mm
Peso aproximado por m ² Theoric Weight M ² /Poids théorique M ²	13,00 kg
Nº de lamas/m. de altura. Slats by meter height/Lames par metre de hauteur	10
Ancho máximo recomendado Max recommande witch/Largeur max. recomen- dable	6,00 m
Alto máximo recomendado Max. height/Max hauteur	5,00 m
Peso por metro lineal de lama Weight m.l./Poids m.l.	1300 gr/ml
Embalaje Packaging/Emballage	10 lamas/ paq.

CERTIFICACIONES MERCADO CE/CE MARK CERTIFICATIONS/CERTIFICATION MARCAGE CE		
ENSAYO	RESULTADO	DIMENSIONES (mm)*

RESISTENCIA AL VIENTO Resistance to wind Resistance au vent	P*2: ≥620 Pa= 114,5 km/h	4000 x 4000 <small>ancho x alto width x height largeur x hauteur</small>
--	--------------------------	---

DIÁMETRO DE ENROLLAMIENTO	260	300	330	360
ALTURA DE PERSIANA	2000	2800	3800	4600

UNE EN 1932. Clasificación según la tabla 5 (apdo. 4.4) de la Norma UNE EN 13659:2004. Classification upon table 5 (section 4.4) of the UNE EN 13659:2004 regulation. Classification selon tableau 5 (p. 4.4) de la Norme UNE EN 13659:2004.

90031155?? - CÓDIGO/CODE/CODE - 155 BLANCO/WHITE/ BLANC

Alturas totales en mm. Total heights in mm. Hauters total en mm.

* DESCRIPCIÓN COLORES

PERSIANAS - LAMA AL EXTRUSIÓN

ROLLER SHUTTER - EXTRUDED AL SLAT/VOLET ROULANT - LAME ALU EXTRUDÉ



GV-100 EXTR.

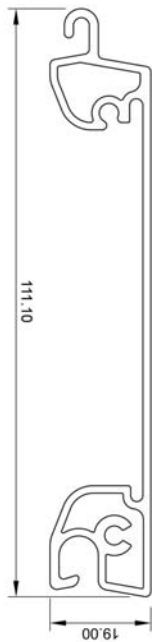

DATOS TÉCNICOS

TECHNICAL DATA / CARACTERISTIQUES TECHNIQUES

Superficie de cobertura Coverage/Couverture	100 mm
Espesor nominal Thickness/Épaisseur	19 mm
Peso aproximado por m ² Theoric Weight M ² /Poids théorique M ²	10 kg
Nº de lamas/m. de altura. Slats by meter height/Lames par metre de hauteur	10
Ancho máximo recomendado Max recommande witch/Largeur max. recomendable	5,50 m
Alto máximo recomendado Max. height/Max hauteur	4,50 m
Peso por metro lineal de lama Weight m.l./Poids m.l.	1,000 gr/ml
Embalaje Packaging/Emballage	10 lamas/ paq.

CERTIFICACIONES MARCADO CE/CE

MARK CERTIFICATIONS/CERTIFICATION MARCAGE CE

ENSAYO	RESULTADO	DIMENSIONES (mm) *
--------	-----------	--------------------

RESISTENCIA
AL VIENTO
Resistance to wind
Resistance au vent

P*2: ≥965 Pa= 114,5 km/h

5500 x 4500

ancho x alto
width x height
largeur x hauteur

DIÁMETRO DE ENROLLAMIENTO

225 250 275 285

ALTURA DE PERSIANA

2000 2800 3800 4400

UNE EN 1932. Clasificación según la tabla 5 (apdo. 4.4) de la Norma UNE EN 13659:2004. Classification upon table 5 (section 4.4) of the UNE EN 13659:2004 regulation. Classification selon tableau 5 (p. 4.4) de la Norme UNE EN 13659:2004.

90031155?? - CÓDIGO/CODE/CODE - 155 BLANCO/WHITE/ BLANC

Alturas totales en mm. Total heights in mm. Hauters total en mm.

* DESCRIPCIÓN COLORES

PERSIANAS - LAMA AL EXTRUSIÓN

ROLLER SHUTTER - EXTRUDED AL SLAT/VOLET ROULANT - LAME ALU EXTRUDÉ



GV-100 ECO EXTR.

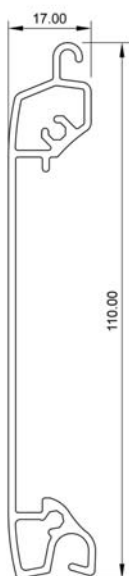

DATOS TÉCNICOS TECHNICAL DATA / CARACTERISTIQUES TECHNIQUES

Superficie de cobertura Coverage/Couverture	100 mm
Espesor nominal Thickness/Épaisseur	17 mm
Peso aproximado por m ² Theoric Weight M ² /Poids théorique M ²	8,53 kg
Nº de lamas/m. de altura. Slats by meter height/Lames par metre de hauteur	10
Ancho máximo recomendado Max recommande witch/Largeur max. recommandable	4,50 m
Alto máximo recomendado Max. height/Max hauteur	3 m
Peso por metro lineal de lama Weight m.l./Poids m.l.	0,853 gr/ml
Embalaje Packaging/Emballage	10 lamas/ paq.

CERTIFICACIONES MARCADO CE/CE MARK CERTIFICATIONS/CERTIFICATION MARCAGE CE

ENSAYO	RESULTADO	DIMENSIONES (mm)*
--------	-----------	-------------------

RESISTENCIA
AL VIENTO
Resistance to wind
Resistance au vent

P*2: ≥965 Pa= 114,5 km/h 4200 x 3000

ancho x alto
width x height
largeur x hauteur

DIÁMETRO DE ENROLLAMIENTO	265	295	325	340
---------------------------	-----	-----	-----	-----

ALTURA DE PERSIANA	2000	2800	3800	4400
--------------------	------	------	------	------

UNE EN 1932. Clasificación según la tabla 5 (apdo. 4.4) de la Norma UNE EN 13659:2004. Classification upon table 5 (section 4.4) of the UNE EN 13659:2004 regulation. Classification selon tableau 5 (p. 4.4) de la Norme UNE EN 13659:2004.

90031155?? - CÓDIGO/CODE/CODE - 155 BLANCO/WHITE/ BLANC

Alturas totales en mm. Total heights in mm. Hauters total en mm.

* DESCRIPCIÓN COLORES

GUÍAS PERSIANAS

COULISSES VOLET ROULANT

ROLLER SHUTTER GUIDES



gaviota

Sun Life Specialist

PVC H-26



PVC 30 x 60

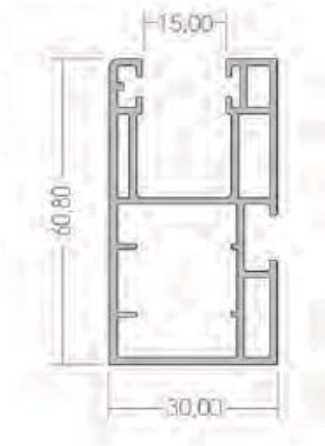

CENTRAL PVC

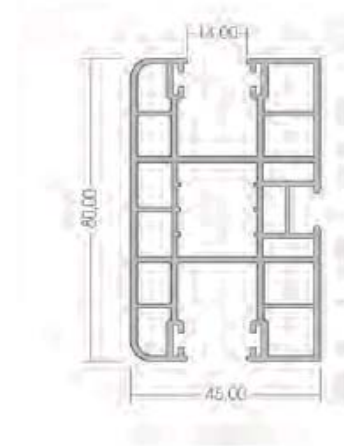

PVC UNIVERSAL



PVC ADELANTADA

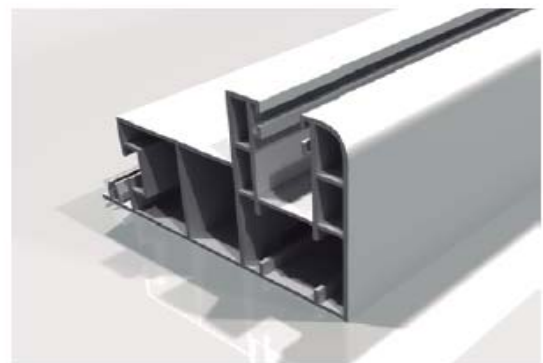

30 x 26

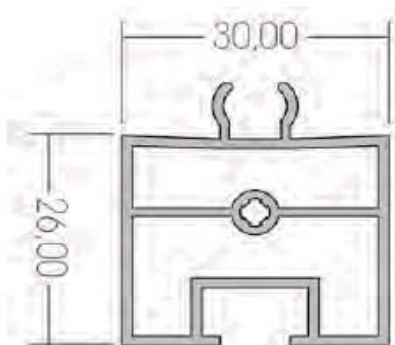

30 x 55



PERSIANAS - GUÍAS ALUMINIO

ROLLER SHUTTER - ALUMINIUM GUIDE/VOLET ROULANT - COULISSE ALUMINIUM



EXT H-25

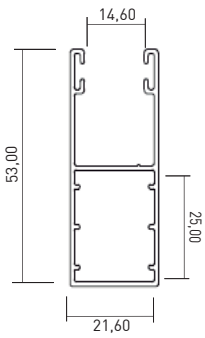

EXT H-40

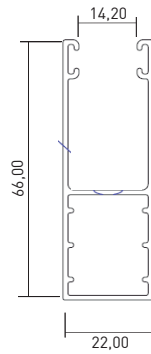

EXT 2T

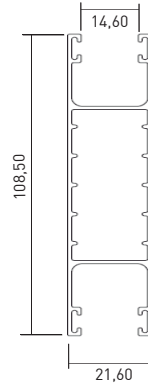

EXT DYNAMIC-SECUR

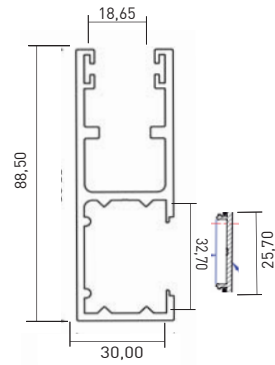

EXT H-75

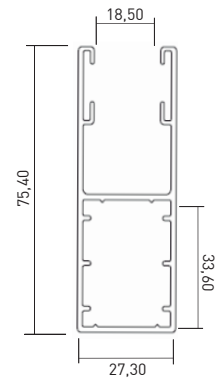

EXT H-95

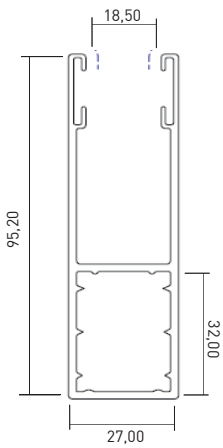

EXT H-90

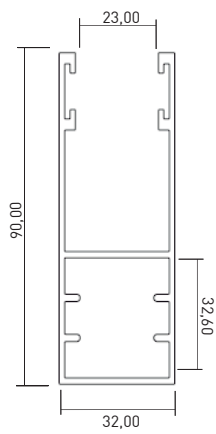

EXT H-100

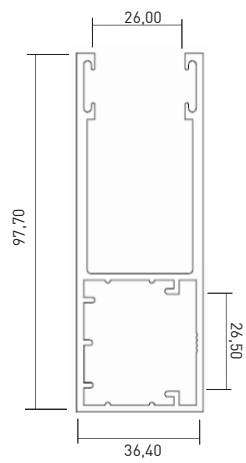

EXT HSL-A 120

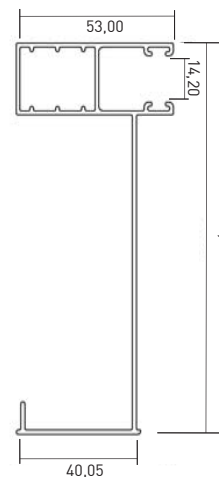

EXT HSL-A 155

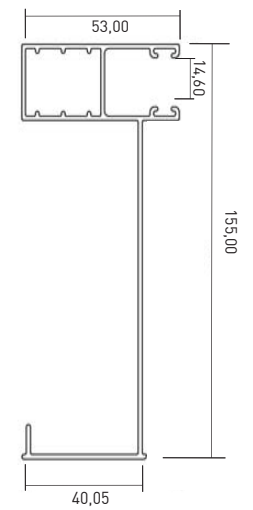

EXT FT1

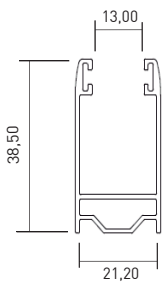

EXT FT2

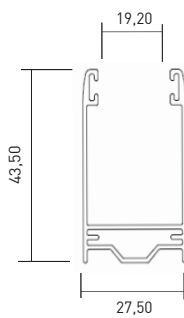

EXT FT3

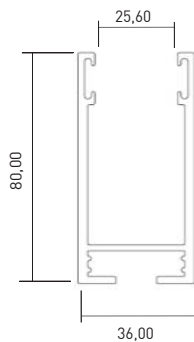

EXT U-25

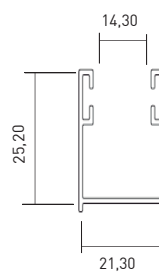

EXT U-70

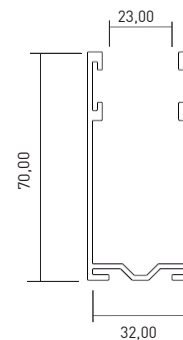

EXT EMB1

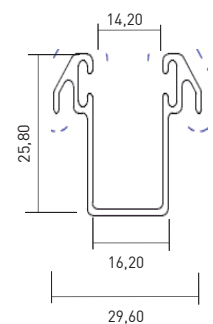

PERSIANAS - GUÍAS ALUMINIO

ROLLER SHUTTER - ALUMINIUM GUIDE/ VOLET ROULANT - COULISSE ALUMINIUM



CORRESPONDENCIA LAMAS - GUÍAS

LAMAS/LAME/SLATS	PVC-26	PVC 30 X 60	CENTRAL PVC	PVC UNIVERSAL	PVC ADELAN	PVC 30 X 26	PVC 30 X 55	EXT H-25	EXT H-40	EXT 2T	EXT DYNAMIC-SECUR
GV-39 PVC	•	•	•	•	•	•	•	•	•	•	
GV-44 PVC	•	•	•	•	•	•	•	•	•	•	
GV-45 PVC RECTA											
GV-50 PVC											
GV-56 PVC											
GV-39 AL PF	•	•	•	•	•	•	•	•	•	•	
GV-45 AL PF	•	•	•	•	•	•	•	•	•	•	
GV-45 ECO AL PF	•	•	•	•	•	•	•	•	•	•	
GV-45 RECTA AL PF	•	•	•	•	•	•	•	•	•	•	
GV-55 AL PF											
GV-77 AL PF											
GV-40 EXTR.	•	•	•	•	•	•	•	•	•	•	
GV-24 MICRO EXTR.	•	•	•	•	•	•	•	•	•	•	
GV-60 EXTR.											•
GV-45 AUTOB. EXTR.	•	•	•	•	•	•	•	•	•	•	
GV-45 ECOCLIM AUTOB. EXTR.	•	•	•	•	•	•	•	•	•	•	
GV-60 AUTOB. EXTR.											•
G.V-90 AUTOB. EXT											
GV-100 EXTR.											
GV-100 ECO EXTR.											

LAMAS/LAME/SLATS	EXT H-75	EXT H-95	EXT H-90	EXT-H-100	EXT HSL-A 120	EXT HSL-A 155	EXT FT1	EXT FT2	EXT FT3	EXT U-25	EXT U-70	EXT EMB1
GV-39 PVC					•	•	•			•		•
GV-44 PVC					•	•	•			•		•
GV-45 PVC RECTA	•	•						•				
GV-50 PVC	•	•						•				
GV-56 PVC	•	•						•				
GV-39 AL PF					•	•	•			•		•
GV-45 AL PF					•	•	•			•		•
GV-45 ECO AL PF					•	•	•			•		•
GV-45 RECTA AL PF					•	•	•			•		•
GV-55 AL PF	•	•						•				
GV-77 AL PF			•	•					•		•	
GV-40 EXTR.					•	•	•			•		•
GV-24 MICRO EXTR.					•	•	•			•		•
GV-60 EXTR.	•	•						•				
GV-45 AUTOB. EXTR.					•	•						•
GV-45 ECOCLIM AUTOB. EXTR.					•	•						•
GV-60 AUTOB. EXTR.	•	•										
G.V-90 AUTOB. EXT			•	•					•		•	
GV-100 EXTR.			•	•					•		•	
GV-100 ECO EXTR.			•	•					•		•	

PERSIANAS - GUÍAS ALUMINIO

ROLLER SHUTTER - ALUMINIUM GUIDE/VOLET ROULANT - COULISSE ALUMINIUM



CORRESPONDENCIA GUÍAS - FELPUDOS - GOMAS

GUÍAS	FELPUDOS				GOMAS			
	4,5 X 4,80	5,50 X 6,9	8 X 12,70	5 X 17	3,30 X 6,50	3,9 X 7	5,3 X 12,8	4,20 X 16
PVC-26		•			•			
PVC 30 X 60		•			•			
CENTRAL PVC		•			•			
PVC UNIVERSAL		•			•			
PVC ADELAN		•			•			
EXT H-25		•			•			
EXT H-40		•				•		
EXT 2T		•				•		
EXT DYNAMIC-SECUR						•		
EXT H-75				•				•
EXT H-95				•				•
EXT H-90			•				•	
EXT-H-100			•				•	
EXT HSL-A 120		•				•		
EXT HSL-A 155		•				•		
EXT FT1	•							
EXT FT2	•							
EXT FT3			•				•	
EXT U-25		•				•		
EXT U-70			•				•	
EXT EMB1		•				•		

REMATES PERSIANAS

LAME FINALE VOLET ROULANT

ROLLER SHUTTER END SLAT



gaviota

Sun Life Specialist

PERSIANAS - REMATES

ROLLER SHUTTER - END SLAT/VOLET ROULANT - LAME FINALE



RTE AL INTERIOR

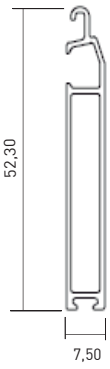

RTE AL DOBLE

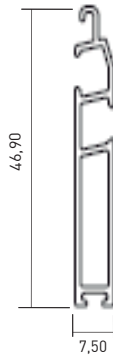

RTE AL GV-45 AUTO/ECOCLIM

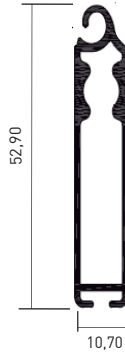

RTE AL GV-55

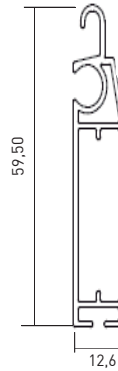

RTE AL GV-24

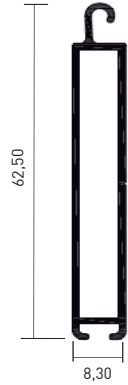

RTE AL GV-60 AUTOBLOCK

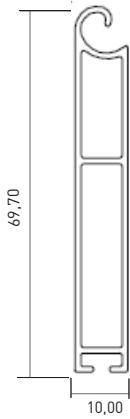

RTE AL GV-77



RTE AL GV-95 AUTOBLOCK

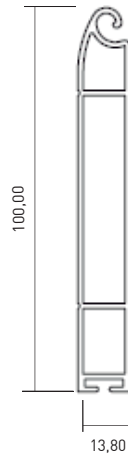

RTE AL GV-100/ECO

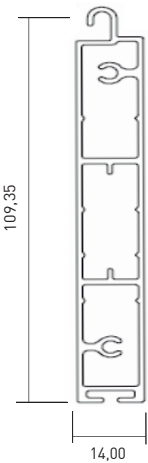

RTE PVC LAMA GV - 56

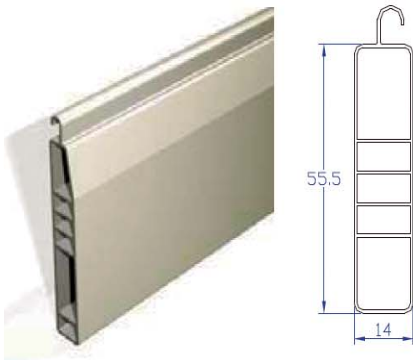

RTE PVC LAMA GV- 39/45

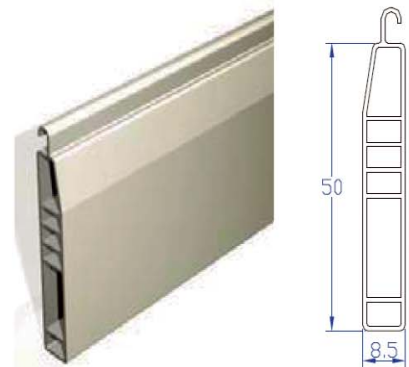



CORRESPONDENCIA GUÍAS - LAMAS - REMATES

PVC

ALUMINIO

LAMAS/LAME/SLATS	DIM LAMA H X L	RTE PVC LAMA GV- 39/45	RTE PVC LAMA GV - 56	RTE AL INTERIOR	RTE AL DOBLE	RTE AL GV-45 AUTO/ECOCLIM	RTE AL GV-55
GV-39 PVC	39 X 8	•					
GV-44 PVC	44X 9,5	•					
GV-45 PVC RECTA	45 X 14,5		•				
GV-50 PVC	50 X 14,5		•				
GV-56 PVC	56 X 14,5		•				
GV-39 AL PF	39,25 X 9,7			•	•		
GV-45 AL PF	45 X 9,7			•	•		
GV-45 ECO AL PF	45 X 9			•	•		
GV-45 RECTA AL PF	45 X 8,8			•	•		
GV-55 AL PF	55 X 13,5						•
GV-77 AL PF	77 X 20						
GV-40 EXTR.	40 X 8,7			•	•		
GV-24 MICRO EXTR.	24 X 7,6						
GV-60 EXTR.	60 X 13						•
GV-45 AUTOB. EXTR.	41,82 X 8,6					•	
GV-45 ECOCLIM AUTOB. EXTR.	44 X 9,1					•	
GV-60 AUTOB. EXTR.	62,75 X 14,81						
G.V-90 AUTOB. EXT	84,50 X 16,47						
GV-100 EXTR.	110 X 17						
GV-100 ECO EXTR.	110 X 17						
GOMA/RUBBER/GOMME		NO	NO	5,7X4,4X6,5	5,7X4,4X6,5	10 X 7,60 X 13	10 X 7,60 X 13

ALUMINIO

LAMAS/LAME/SLATS	DIM LAMA H X L	RTE AL GV-24	TE AL GV-60 AUTOBLOC	RTE AL GV-77	RTE AL GV-95 AUTOBLOCK	RTE AL GV-100/ECO
GV-39 PVC	39 X 8					
GV-44 PVC	44X 9,5					
GV-45 PVC RECTA	45 X 14,5					
GV-50 PVC	50 X 14,5					
GV-56 PVC	56 X 14,5					
GV-39 AL PF	39,25 X 9,7					
GV-45 AL PF	45 X 9,7					
GV-45 ECO AL PF	45 X 9					
GV-45 RECTA AL PF	45 X 8,8					
GV-55 AL PF	55 X 13,5					
GV-77 AL PF	77 X 20			•		
GV-40 EXTR.	40 X 8,7					
GV-24 MICRO EXTR.	24 X 7,6	•				
GV-60 EXTR.	60 X 13					
GV-45 AUTOB. EXTR.	41,82 X 8,6					
GV-45 ECOCLIM AUTOB. EXTR.	44 X 9,1					
GV-60 AUTOB. EXTR.	62,75 X 14,81		•			
G.V-90 AUTOB. EXT	84,50 X 16,47				•	
GV-100 EXTR.	110 X 17					•
GV-100 ECO EXTR.	110 X 17					•
GOMA/RUBBER/GOMME		5,7 X 6 X 6,5	10 X 7,60 X 13	13X9X15	10 X 7,60 X 13	10 X 7,60 X 13

gaviota
Sun Life Specialist

GAVIOTA
Autovía de Alicante A-31, Km.196
03630 Sax (Alicante) - España / Spain
Info@gaviotasimbac.com